



MECHANICAL PRODUCT CATALOG

Visit our
website



Client:

Contact:

Date:

Project Number:

Project Name:

Pages (10-11)

Valent designs and manufactures dedicated outdoor air handling units that require robust cabinets and components to effectively condition 100% outdoor air — on the coldest winter day or the most humid summer day. Efficient manufacturing allows Valent to provide affordable products while raising the bar on quality.

Pages (12,15)

Haakon Industries is a world leader in custom designed and manufactured air handling units. Our experienced engineering staff provides the highest quality, creative, rapid design service and our manufacturing process brings your ideas to life.

Pages (13,15)

Innovent
Air Handling Equipment

Since 1981, Innovent Air Handling Equipment has met the specialized needs of thousands of customers across North America, providing custom solutions for a wide range of facilities, including educational, health care, industrial, government, hospitality, recreational, research and retail.

Page (14,15)



Air Zone International offers a line of high quality air handling products based on years of research and development, using only nationally recognized components. Air Zone's products continue to be the basis of design on some of the greenest buildings in North America. The rugged yet flexible designs offered by Air Zone International employ state of the art components applied with knowledge and skill. Air Zone's goal is to meet engineers' rigid specifications by applying the exact components required and to bring forth the completed product according to the understood requirements of the purchaser. Air Zone International provides a state of the art design with independent testing and certification to meet the requirements of every customer.

Pages (16-17)

PoolPak[®]

PoolPak[®] is recognized as a leading brand of dehumidification systems for large athletic pools, natatoriums in schools and universities, commercial pools and hotel/motel leisure pools. Our Proven Approach to dehumidification is your best assurance for optimum space and water conditions while keeping operating cost low through recycled energy.

Page (18-19)**ENVIRO-TEC[®]**

ENVIRO-TEC products for zone control air conditioning meet the highest standards for quiet, efficient performance.

Manufactured since 1979 in Largo, Florida, ENVIRO-TEC products are shipped around the world to air condition office buildings, hospitals, universities, schools, stores, hotels and multifamily dwellings.

Page (20-21)**RRS**
ROOFTOP
SYSTEMS**RUSKIN[®]**
GO GREEN  GO RUSKIN

At RRS we proudly serve HVAC original equipment manufacturers, HVAC distributors and a wide variety of national account customers, including national retailers and restaurants. We have used our patented technology and engineering expertise to build a full line of accessories for commercial HVAC equipment as well as an innovative line of Energy Recovery Ventilators.

Page (22-23)

AbsolutAire has a reputation for excellence throughout the gas fired make-up air industry. This reputation is built on a solid foundation of especially strong working relationships with specifying engineers, contractors, and facility owners and operators. AbsolutAire's customers come in most every size and type imaginable.

Pages (24-25)



Quantech chillers are a line of air-cooled and water-cooled chillers. Quantech chillers are manufactured as part of the Johnson Controls product portfolio in manufacturing plants in North America. All chillers are AHRI certified and meet other industry-wide standards such as ETL, UL, and ASHRAE.

Pages (26-27)



Smartd oil-free centrifugal chillers offer the highest IPLV energy efficiencies and the lowest lifetime operating costs in their capacity ranges - 60 TR through 3600 TR in water-cooled, 60 TR through 450 TR in air-cooled and 60 TR through 300 TR in evaporative-cooled.

Pages (28-29)



SteamOvap technologies is a Canadian manufacturer of humidifiers for the commercial and industrial HVAC market. Its founders combine more than 35 years of experience in building humidification equipment. SteamOvap is born out of our desire to offer energy efficient solutions that are using the latest available technologies in order to bring a new alternative to the humidification market.

Page (30-31)

Advanced Cooling Technologies, Inc. (ACT) is a premier thermal management solutions company, providing design and manufacturing services to meet our customers' needs across all points of the product lifecycle. We serve our global customers' thermal management and energy recovery needs in diverse markets including Defense, Aerospace, Electronics, HVAC, Medical, Enclosure Cooling and Calibration Equipment.

Page (15)

At Cooney Technologies, we solve age-old industry problems with inventive solutions. Our passion for bringing simple yet innovative solutions to the HVAC industry has been the primary driver in creating our patented Freeze Block™ technology and launched the Cooney team into the manufacturing environment. We continue to develop these technologies as well as help solve new challenges with our team.

Page (32-33)

Enerco, based in Cleveland Ohio, has been at the forefront of infrared combustion technology since 1957. This market leading technology has allowed Enerco to build expertise in consumer heating products as well as heavy duty commercial and construction heating products. Enerco's three market leading brands deliver safety and comfort worldwide.

Page (34-35)



Aero Tech manufactures its own line of radiant ceiling panel products for the construction and HVAC industry. Radiant heating panel systems function based on providing a comfortable environment by controlling surface temperatures and minimizing excessive air motion within the space.

Pages (36-37)



INTEC Controls offers a complete line of sensors and controllers used with ventilation systems to prevent the dangerous accumulation of toxic and combustible gases, including carbon monoxide, nitrogen dioxide, methane, hydrogen, ammonia, refrigerant gases, carbon dioxide, volatile organic compounds (VOCs) and many more.

Pages (38-39)**VMC GROUP**

THE POWER OF TOGETHER™

VMC Group has been recognized as a world leader in the design and manufacture of vibration isolation, seismic control and shock protection products. Our comprehensive product and engineering solutions cover a variety of industries – commercial construction, industrial/vehicular, OEM and military/aerospace. Our full range of spring, elastomeric architectural mounts, wire rope isolators, curbs and bases are proven to meet and exceed specifications for any seismic, non-seismic, shock, or even bomb blast application.

Page (15)***AcoustiFLO***

AcoustiFLO began in the 90's offering the most aerodynamic and acoustically efficient axial fan towers available to the world's top tier semi-conductor manufacturers. Utilizing our in-house engineering capabilities, this same technology was applied to office buildings and high tech facilities in multiple cities and sites across the U.S. Adjusting to changes in the manufacture of semiconductors and in HVAC system design, in early 2004 AcoustiFLO developed its patented modular fan system, the 686q. The 686q offers a blend of the high efficiency of larger fans combined with the modular flexibility and acoustic advantages of smaller multiple fans.

Page (15)



Today, Filtration Group Indoor Air Quality is one of the largest and most advanced filtration manufacturers in the United States and Canada. Our vast network of manufacturing, sales, and engineering facilities around North America, FG IAQ is at the industry forefront in filtration solutions for the commercial, healthcare, gas, cleanroom, biosafety and general HVAC industries.

Page (15)



UltraViolet Devices, Inc. was incorporated in 1992 but as a third generation, family owned business our roots date back to 1949 when Lou Veloz founded Aquafine Corp. Then and now, innovation and dedication to the science behind UV disinfection has carried UVDI to become the industry leader in surface and air disinfection. Along with our focus and expertise in bonded activated carbon filtration, we are bringing solutions to a number of important issues that face us today. From infection prevention in healthcare settings to indoor air quality solutions and beyond, UVDI is here to help make the world a healthier, safer and cleaner place.

Scan the QR code to get directed to Deckman Company's website for the most up-to-date information on our manufacturers and the products that we offer.



Key Features:

- **Robust Cabinet Design:** 2" double wall, foam injected, high quality casing, and paint are all standard features.
- **Ultra Quiet Operation:** Due to ultra quiet condensing fans and inverter compressor.
- **Full Width Energy Wheels:** All air flows through wheel for maximum efficiency
- **Enthalpy Core:** No moving parts, reduced maintenance
- **High Turndown Furnace:** A turndown of 16:1 is available with some models.
- **Easy Startup:** All units are run for a minimum of 90 minutes to ensure a fast trouble free startup and reliable operation.

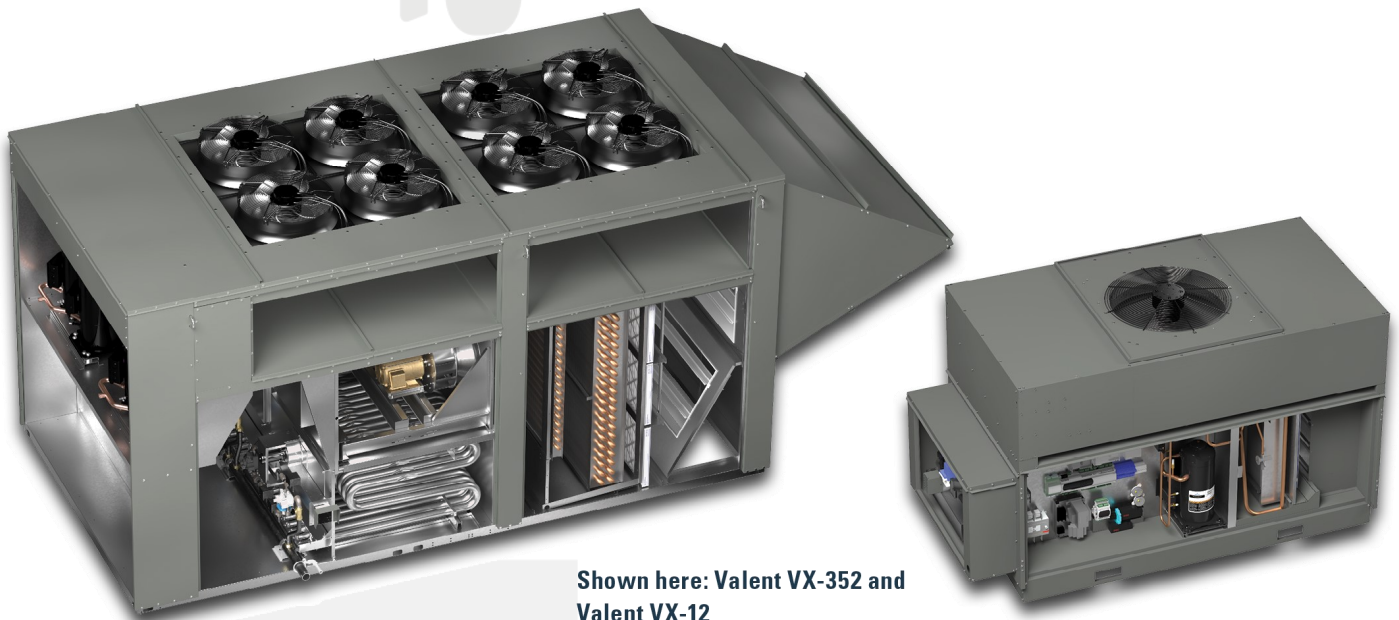

Shown here: Valent VX-352 and
Valent VX-12

		VX, VXE, & VXC Casing				
		12	112	212	312	352
AIR-FLOW	Minimum (cfm)	500	800	2,250	3,750	3,900
	Maximum (cfm)	2,500	6,500	9,500	16,000	18,000
COOLING TYPE	Packaged, air cooled	Tons	Tons	Tons	Tons	Tons
		3	5	15	25	30
		4	7	17.5	30	40
		5	10	20	40	50
		6	12.5	25	50	60
		7	15	30	—	70
		Circuits	Circuits	Circuits	Circuits	Circuits
	1	1	2	2	2	
	Chilled water	Not available	Option	Option	Option	Option
	Air source heat pump	Not available	Option	Option	Not available	Not available
No cooling	Option	Option	Option	Option	Option	
COOLING COMPONENTS	Inverter scroll compressor	Standard	Standard	Standard	Standard	Standard
	Modulating hot gas reheat	Option	Option	Option	Option	Option
	Lead EC modulating condensing fans	Standard	Standard	Standard	Standard	Standard
	All EC modulating condensing fans	Not applicable	Option	Option	Option	Option
	Minimum (MBh)	75	100	300	600	600
INDIRECT GAS FURNACE	Maximum (MBh)	200	300	500	1,200	1,200
	Turndown (NG)	Up to 16:1	Up to 16:1	Up to 16:1	Up to 16:1	Up to 10:1
	Turndown (LP)	Up to 16:1	Up to 16:1	Up to 16:1	Not available	Up to 6:1
	Minimum (kW)	4	15	35	35	50
ELECTRIC HEAT	Maximum (kW)	60	60	120	230	200
	Air source heat pump	Not available	Option	Option	Not available	Not available
OTHER HEAT	Hot water	Not available	Option	Option	Option	Option
	Steam coil	Not available	Option	Option	Option	Option
	Full width wheel (Polymer)	Not available	Option	Option	Option	Option
ENERGY RECOVERY	Full width wheel (Aluminum)	Not available	Option	Option	Option	Option
	Enthalpy core	Not available	Option	Option	Not available	Option
	Full controls	Standard	Standard	Standard	Standard	Standard
CONTROLS	Heat-cool only	Option	Option	Option	Option	Option
	Web user interface	Standard	Standard	Standard	Standard	Standard
	Insulation	2" double-wall R-13	2" double-wall R-13	2" double-wall R-13	2" double-wall R-13	2" double-wall R-13
CONSTRUCTION	Exterior	Gray prepainted	Gray prepainted	Gray prepainted	Gray prepainted	Gray prepainted
	Interior	Galvanized	Galvanized	Galvanized	Galvanized	Galvanized
	AHRI 1060	N/A	Compliant	Compliant	Compliant	Compliant
CERTIFICATION	ASHRAE 90.1-2013	Compliant	Compliant	Compliant	Compliant	Compliant
	DOE AHRI 340/360	Compliant	Compliant	Compliant	Compliant	Compliant
	DOE AHRI 340/360	Compliant	Compliant	Compliant	Compliant	Compliant

HAAKON
INDUSTRIES[®]



Manufacturing is supported by three factories; Richmond, BC, Cheney, WA, and Kingston, ON. Utilizing a wide range of materials and diverse suppliers, each component is custom made for the specific unit; from access doors to fanbases.

Each factory leverages state of the art equipment to ensure the highest level of quality and each unit undergoes extensive quality control unique to each and every unit.



- Flexible Cabinet Construction
- Packaged Direct Expansion Cooling
 - Heat Recovery Options
 - Desiccant Dehumidification
 - Fan Options
 - Custom Coil Options
 - Filtration Options
 - Custom Heating Options



- Custom Air Handling Units (up to 110,000 CFM)
- Rooftop Air Handling Units (up to 180,000 CFM)
- Modular Air Handling Units (up to 110,000 CFM)
 - Hospital Grade Air Units (up to 60,000 CFM)
 - Air Rotation Units (up to 80,000 CFM)



AcoustiFLO

- Unmatched for sound sensitive applications
- 10 to 20 dB quieter than competing fans
- Centrifugal fan wheels with patented diffuser and slotted aluminum air-path technology

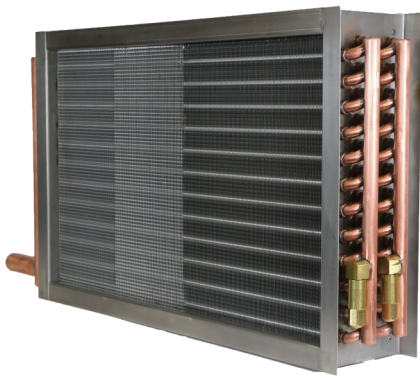

Products

ComPak PCP Features:

- Capacities from 2 to 16 tons
- Supply air from 550 to 8,000 CFM
- Vertical/horizontal and indoor/outdoor configurations
- Small footprint, ultra efficient dehumidification technology
- State of the art, corrosion resistant design

- 1) Critical component protection
- 2) Space & energy efficient design
- 3) Optional features
- 4) PoolPak Web Sentry



COMPAK® PCP VERTICAL



COMPAK® PCP HORIZONTAL

StakPak PCP Features:

- Capacities from 8 to 32 tons
- Supply air from 2,600 to 13,000 CFM
- Field splittable for easy installation into tight retro-fit applications
- Two independent, fully redundant circuits that provide optimum scalable energy efficiency
- Industry leading moisture removal for efficient dehumidification

- 1) Small footprint, high performance
- 2) Critical component protection
- 3) PoolPak Web Sentry



PPK Series Features:

- Capacities from 18 to 128 tons
- Supply air from 6,800 to 64,000 CFM
- All critical components located outside of chlorinated airstream
- Fluid cooled mechanical refrigeration system provides improved energy savings
- Outside air/exhaust air energy recovery loop options
- Utilizes up to 85% less refrigerant charge
- PoolPak's proprietary heat rejection design makes the PPK Series 5-7% more efficient compared to all traditional DX systems throughout the year



PoolPak's Web Sentry: Virtual Tech Monitoring System

- 24/7 remote real time monitoring
- Simple ethernet connection
- Allows factory engineers to remotely monitor, analyze and fine tune over 100 critical dehumidifier functions
- Provides performance trouble alerts and maintenance reminders
- Activation of virtual tech increases labor warranty from 90 days to 12 months



ESL & MQL Air Handling Units

Model ESL Indoor Air Handling Unit

- Airflow: 1,000 to 50,000 CFM
- 1% leakage of design CFM at ± 8 in. w.g.
- 2" foam injected panels, R-13 insulation
- Double wall construction
- Optimized fan selections: FC, airfoil, plenum fans
- VFD control
- Water, DX, steam & glycol coils, electric heat, indirect gas fired
- MERV 8, 11, 14, 15 rated filters are available
- UV lights
- Energy recovery heat wheels
- Roof mounted unit available









Model MQL Indoor Air Handling Unit

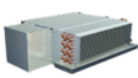

- Airflow: 600 to 10,000 CFM
- Single and double wall construction
- Modular cabinet design – horizontal & vertical arrangements
- Optimized forward-curved fan selections
- Removable access panels / optional hinged access
- Single point power connection
- Factory mounted starters / VFD
- Water, DX, steam & glycol coils, electric heat
- IAQ galvanized drain pan, stainless steel is optional
- MERV 8, 11, 14, 15 rated filters are available



Fan Coil Units

Horizontal Low-Profile	Horizontal High Performance	Vertical Floor Mounted	Vertical Low-Profile	Vertical High Performance	Vertical High-Rise
					
200-1,200 cfm	600-2,400 cfm	250-1,250 cfm	200-600 cfm	400-2,000 cfm	350-1,200 cfm
HLP Plenum Return	HPP Plenum Return	VFE Flat Top	VLE Exposed Cabinet	CDV Front Return	VHC Concealed Cabinet
HLF Free Return	HPF Free Return	VFS Sloped Top	VLC Concealed Cabinet	CDVB Bottom Return	VHE Exposed Cabinet
HLE Exposed Cabinet	HPE Exposed Cabinet	VFC Concealed Cabinet	N/A	CDVM Mixing Box	VHM/VHS/VHA/VHB Master/Slave Tandem
Galvanized Steel Construction					
Single Wall Construction – Fiberglass, Closed Cell Foam, Foil Faced					
Galvanized Drain Pan. Optional Stainless Steel					
Forward Curved PSC Direct Drive Fans. Optional; ECM Motor (Except VL Series)					
Water, Steam, DX, Electric Coils					
Throwaway Filters. Optional MERV 8 or 13					
Single Point Power Connection					
Optional Piping Packages (Except VL & CDV)					
Optional Thermostats					

Blower Coil Units

Direct Drive Vertical / Horizontal	Belt Drive Vertical – Reduced Footprint
	
250-5,000 cfm	800-3,000 cfm
HDD - Horizontal Direct Drive	VB - Bottom Return
VDD - Vertical Direct Drive	VR - Rear Return
18 ga Galvanized Steel Cabinet	18 ga Galvanized Steel Cabinet
Single or Double Wall Construction, up to 3" TSP	Single Wall, 1" Foil Faced Insulation
Removable Access Panels. Optional Hinged	Removable Access Panels
IAQ Galvanized Drain Pan. Optional Stainless Steel	Galvanized Drain Pan. Optional Stainless Steel
Direct Drive FC Fans with ECM Motors	Forward Curved Belt Drive Fans
Water, DX, Steam, Electric Coils	Water, Steam, DX, Electric Coils
MERV 8 Filters with Side Access, Optional H.E. Filters	2" Throwaway Filters. Optional MERV 8
Optional Piping Packages	Optional Piping Packages

- Standard Design Features
- Additional Design Choices

● **Motorized Intake and Exhaust Dampers**
 Ruskin's motorized dampers seal tight when the ERV is not in operation. These options are fully factory wired to EnERVent+'s control system.

■ Powered by Lau Silent Pro Series forward curved blowers with isolation to reduce noise and vibration.

■ Double wall construction with 1" fully insulated galvanized steel panels.

■ 2" MERV 8 filters come standard for both the intake and exhaust sections of EnERVent+.

● MERV 13 filters also available on LEED/Green projects.

■ Digital control box that allows for integration with automated building control systems.

● Pre-heat Frost Control

■ Enthalpy Energy Recovery Wheel

- Optional Sensible Only
- Optional Purge Section

● **Coil Options**

- Chilled Water (Shown)
- Hot Water
- Split DX
- 4 Pipe, both Chilled and Hot Water

■ Heavy duty double constructed insulated bottom to help ensure rigidity during transit and installation.

● **Post Heat**

- Staged Electric Heater
- Indirect Gas-Fired Heater

● **Optional Horizontal Discharge**

■ Single point wiring with fused NEMA 3R disconnect switch and low voltage strip for easy installation. Electric pre-heat and post-heat require field installed power.

■ Hinged panel access doors, with quarter turn latches, allow easy access to energy recovery wheel, coils, filters and blowers.

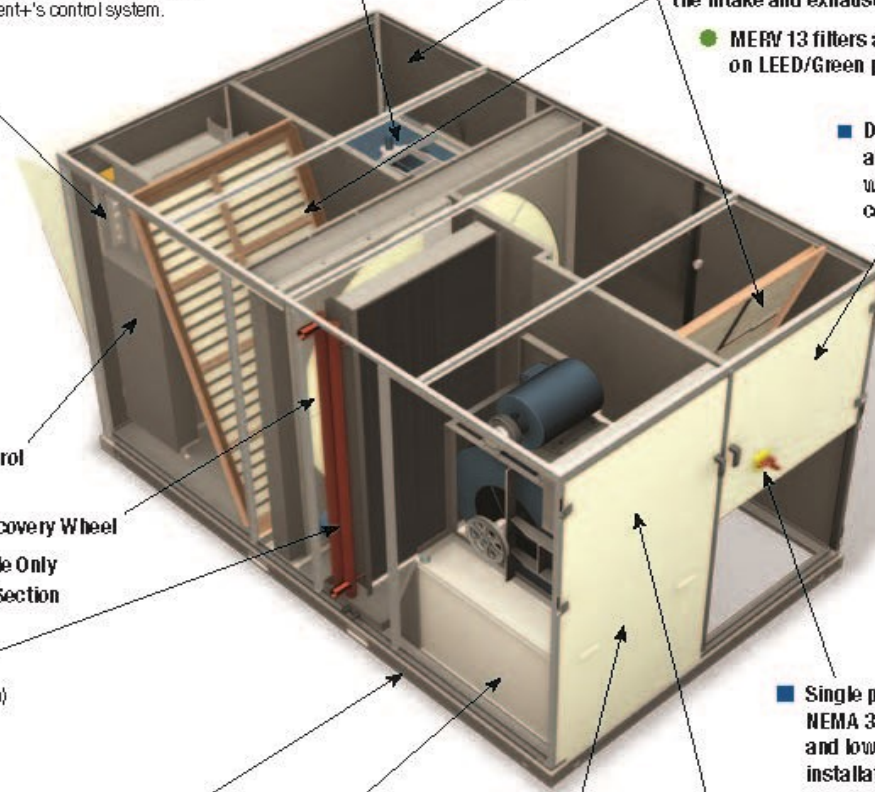

SPECIFICATIONS

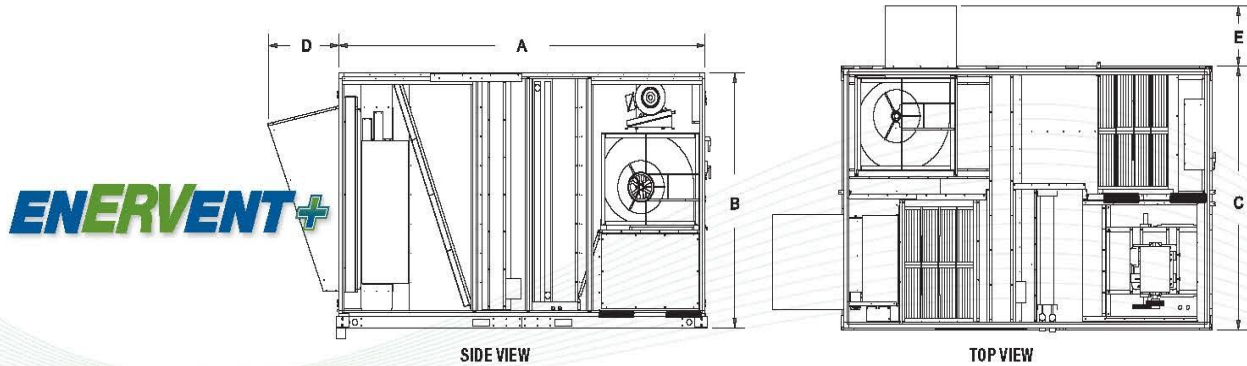

DIMENSIONS (Inches) Base Unit

Model	A	B	C	D	E	Weight (lbs)
EVT-010 / EVT-019	77	43	45	15	10	1350 / 1500
EVT-028 / EVT-036	98	53	55	19	14	2350 / 2500
EVT-046 / EVT-062	116	66	68	23	18	2700 / 3000
EVT-074 / EVT-088	135	77	79	25	20	4700 / 5000
EVT-100 / EVT-120	144	87	88	28	22	5600 / 6000

DIMENSIONS (Inches) Units that require any of the following options: Field Convertible Horizontal Discharge, Gas Heat, or 4 Pipe Water Coil

Model	A	B	C	D	E	Weight (lbs)
EVT-010/ EVT-019	94	47	52	15	10	1510 / 1670
EVT-028 / EVT-036	109	54	61	19	14	2610 / 2780
EVT-046 / EVT-062	131	67	74	23	18	3080 / 3330
EVT-074 / EVT-088	150	77	89	25	20	5210 / 5560
EVT-100 / EVT-120	162	88	101	28	22	6230 / 6670

PERFORMANCE

Model	EVT-010	EVT-019	EVT-028	EVT-036	EVT-046	EVT-062	EVT-074	EVT-088	EVT-100	EVT-120	
CFM Range	MIN	600	900	1600	2400	3000	3400	5400	6400	7600	8000
	MAX	1000	1900	2800	3600	4600	6200	7400	8800	10000	12000
Supply Motor HP	MIN	1	1	1.5	2	2	3	3	5	5	7.5
	MAX	1.5	2	3	5	5	7.5	7.5	10	10	15
Exhaust Motor HP	MIN	1	1	1	1.5	2	2	3	5	3	5
	MAX	1.5	2	2	3	5	5	7.5	10	7.5	10
External Static Supply (in.wg)	*MAX	1.5 - 3.0	1.5 - 3.0	1.5 - 3.0	1.5 - 3.0	1.5 - 3.0	1.5 - 3.0	1.5 - 3.0	1.5 - 3.0	1.5 - 3.0	1.5 - 3.0
External Static Exhaust (in.wg)	*MAX	1.5 - 3.0	1.5 - 3.0	1.5 - 3.0	1.5 - 3.0	1.5 - 3.0	1.5 - 3.0	1.5 - 3.0	1.5 - 3.0	1.5 - 3.0	1.5 - 3.0

* Max external static pressure depends on the options selected.

Products

E-Series Direct-Fired Air Turnover

- Clean & green with total energy efficiency
- Heating up to 7,000 MBH, ventilating up to 120,000 CFM
- Competing ATUs consume 25% more gas and produce 25% more CO₂
- Low first cost, simple installation, less maintenance
- As little as 2% OA for safe & efficient combustion

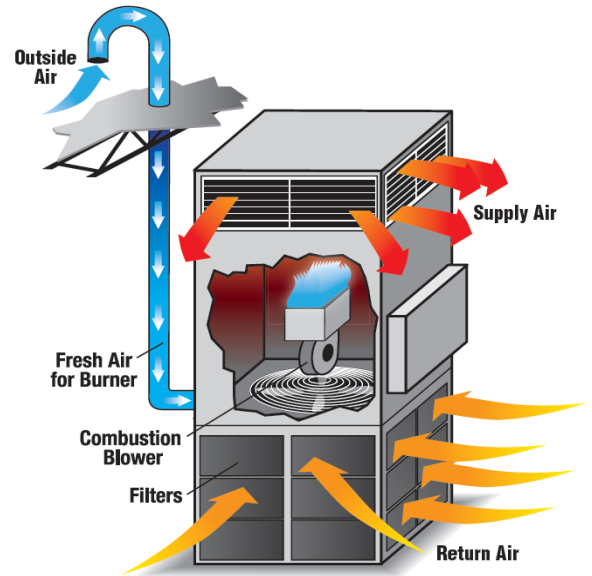

V-Series Direct-Fired: Value-Driven Make-Up Air

- Capacities from 800 to 14,000 CFM
- Maximum make-up air economy
- Value-driven design with advanced features
- Profiler burner profile-adjustment system
- Widely used for kitchen & food-service MUA applications



AA-Series

Direct-Fired Heating, Ventilating & Make-Up Air

- 100% Fresh Air—heated, cooled or both
- Capacities from 200 to 7,500 MBH
- Ventilating capacities from 800 to 54,000 CFM
- Upright or horizontal units for indoor and outdoors
- 100% OA, 80/20 return-air and variable-volume models



I-Series

Indirect-Fired Heating & Ventilating

- Technologies for specific customer preferences
- Heating capacities from 75 to 1,200 MBH input
- Airflow capacities from 600 to 14,800 CFM
- 80% energy efficient with typical heat exchangers
- Gravity vented, power vented or separated combustion (indoor only)
- Indoor and outdoor horizontal models



Absolutaire is a registered trademark of Absolutaire, Inc.

Products

QTC2 & QTC3 Air-Cooled Scroll Chiller

- **Large Capacity Range** 15 through 230 tons air cooled chillers
- **Reliable operation** delivered by a variable flow primary system.
- **Compact design** reduces installation costs and optimize space usage in your facility.
- **Added protection** provided by optional wired/louvered enclosures and robust, formed-steel base.
- **Adaptable design** makes it suitable for indoor or outdoor installation.



QTC4 Air-Cooled Variable Speed Drive Screw Chiller

- **Capacity Range** 150 through 360 tons
- **Save up to 42 percent** on annual energy costs.
- **Variable speed screw compressors** dramatically reduce sound levels and reduce energy consumption.
- **Micro-channel type condenser** for maximum heat transfer and minimum refrigerant charge.
- **Variable primary flow (VPF)** system to reduce the chilled liquid flow to match the building demand.



QRC3 Remote Condenser Scroll Chiller

- **Large Capacity** 50 through 170 tons
- **Rated in accordance** with AHRI standard 550/590.
- **Large internal volume and oil reservoir** provides enhanced liquid tolerance.
- **Pair with** existing or field-provided condenser for simple integrated operation.
- **Efficiency that is superior** to industry standard figures.

QRC3
50-170 TR
REMOTE CONDENSER
SCROLL CHILLER



QWC3/QWC4 Water Cooled Scroll Chillers

- **Capacity Range** 50 through 300 Tons
- **Save up to 37 percent** on annual energy costs.
- **Flexible and adaptable** to meet a wide range of applications.
- **Self-contained design** is perfect for new or retrofit installations.
- **Sustainable** R-410A refrigerant (QWC3) / HFC-134A (QWC4)

QWC3
50-200 TR
WATER-COOLED
SCROLL CHILLER



The QWC4 chiller addresses four primary requirements — efficiency, application flexibility, sustainability, and confidence.

Products



T-Class (45 to 1600 tons)



Smartd's T-Class water-cooled chillers offer class leading performance and are available in a variety of different configurations to suite your project

V-Class (350 to 3600 tons)

Smartd's V-Class range brings new levels of efficiency, reliability, and turn-down to the large water-cooled chiller market – now up to 3600 TR. This is our largest water-cooled oil-free chiller range



CPECS (Plant Optimization)

Using pioneering experience with Turbocor oil-free compressor technology, chiller plant thermodynamics, plant design and control. Kiltch's Central Plant Energy Conversation System (CPECS) ensure end-users get the absolute most out of their plant

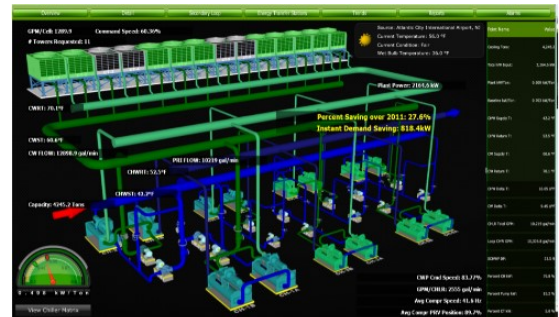

Air-Cooled: G-Class (30 to 520 tons)

Smardt's G-Class air-cooled chillers utilize next-generation low global warming potential refrigerants including R513A, R515B and R1234ze

- Low indoor noise
- Isolation Valves provided to stop the migration of refrigerant when the unit is off
- Efficiencies equivalent to air cooled units
- Glycol is not required in the system

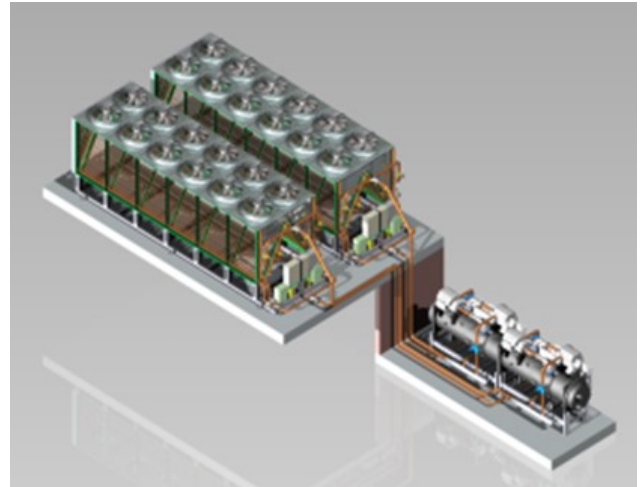

T-Class (40 to 500 tons)



The Smardt air-cooled range offers the smallest footprint, the quietest operation and the highest air-cooled operating efficiencies in its market. Standard Smardt air-cooled chillers are over 70% lower in sound power than a standard screw machine

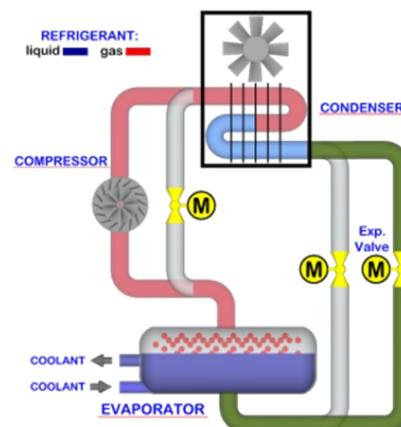
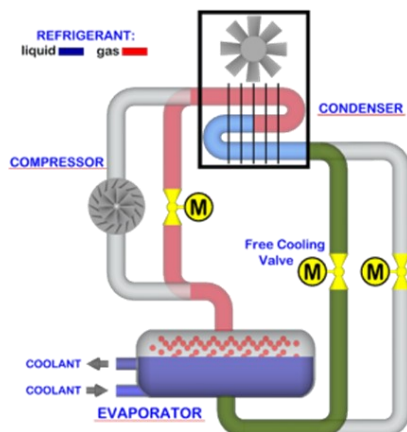

Electric resistive steam humidifier **IER**

- Produces pure and sterile steam in capacities from 6 to 185 lb/h
- Most compact humidifier on the market
- Accepts without alteration pure water (reverse osmosis), softened water or even untreated tap water
- Integrated water drained cooling without the addition of expensive external drain cooler
- Insulated 304 stainless steel evaporation cylinder
- Integrated computer controls w/ 7" touchscreen, can operate standalone or connect to BMS via BACnet, Modbus protocol

Effortless and simple maintenance

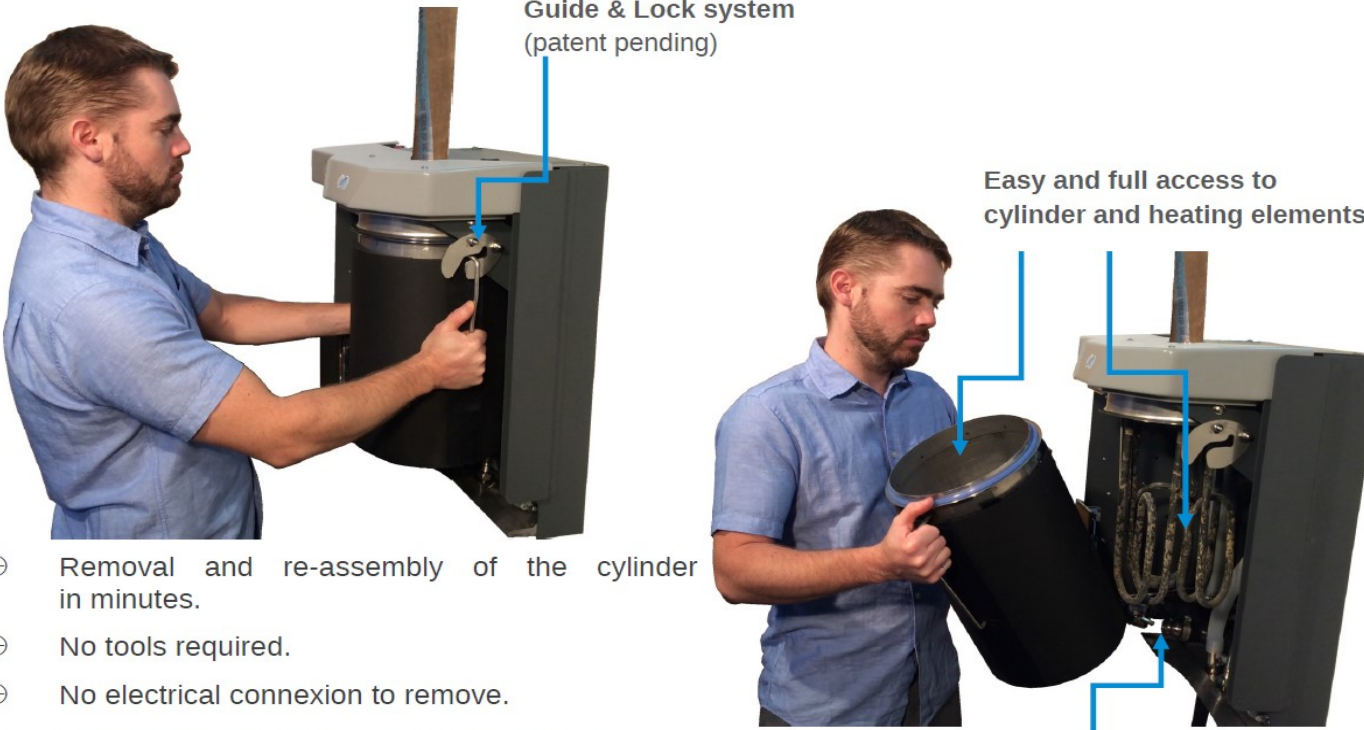

Guide & Lock system
(patent pending)

Easy and full access to
cylinder and heating elements

Stainless steel quick connect

- ⊕ Removal and re-assembly of the cylinder in minutes.
- ⊕ No tools required.
- ⊕ No electrical connexion to remove.
- ⊕ 0 spare part required - not even a gasket !
- ⊕ Humidifier maintenance has never been as simple and easy.

Live steam humidifier ILS

- Capacities from 4 to 3300 lb/h
- Cost effective humidification system for large load
- Can meet very short wetting distance (drip free steam guaranteed)
- 3 year warranty (longest in the industry!)
- Integral 304 stainless steel construction
- Zero water wasted to drain without expensive secondary heat exchange or electrical connection

ILS-SO

LIVE STEAM HUMIDIFIER (STEAMOSORB)

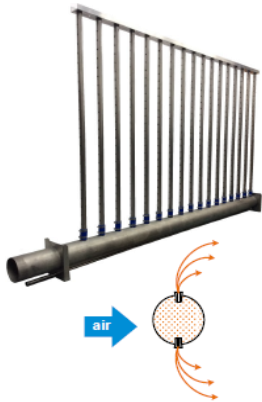

VERTICAL MULTI-RAMP - ATMOSPHERIC CONDENSATE

ILS-SE

LIVE STEAM HUMIDIFIER (HIGH EFFICIENCY STEAMOSORB)

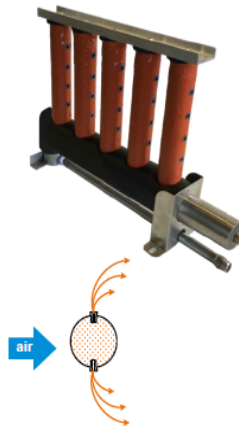

VERTICAL MULTI-RAMP - ATMOSPHERIC CONDENSATE

ILS-P

LIVE STEAM HUMIDIFIER (JACKETED)

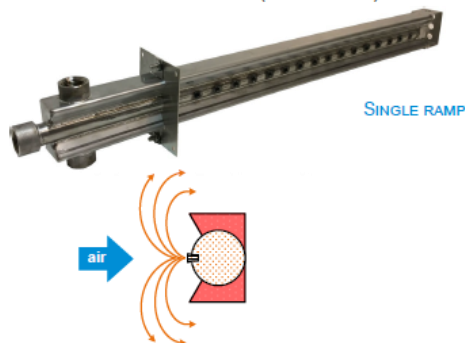

SINGLE RAMP

Products

AAHX (Air-to-Air Heat Pipe Heat Exchanger)

ACT-HP-AAHX is a counter-flow heat exchanger-energy recovery system that features ACT's high-performance, high-reliability heat pipes that can be designed for **new construction or retrofit projects**. Save energy by pre-cooling or pre-heating your incoming building supply air.

- **Tilt controlled AAHX alternate season energy recovery**
 - Tilt aids in defrosting the exhaust stream in winter for servicing needs
 - Increased performance in all season with optimized tilt capability
- **AAHX pump-assisted split loop energy recovery heat exchangers**
 - Compatible with large systems or distance
 - Temperature control is optional
 - Compact packaging & design flexibility

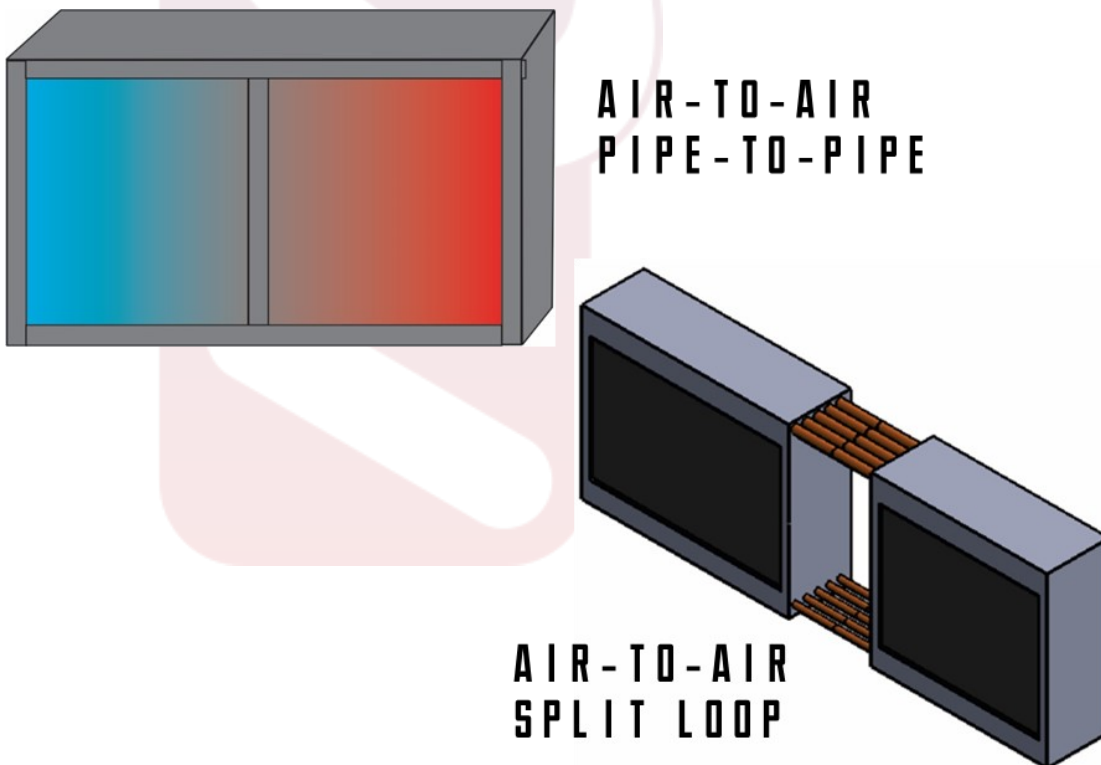

WAHX (Wrap-Around Heat Pipe Heat Exchanger)

ACT-HP-WAHX Wrap-Around systems can be designed for all major AHU OEMs. **For retrofitting existing systems, ACT can ship a pre-engineered unit, fully charged and ready to install.** ACT offers onsite installation for certain projects, or units can be factory installed. **Typical design-build/install costs are recouped in a 1-2 year payback period.**

- Quick return on investment (under 2 years) from energy savings
- Totally passive, no moving parts or system maintenance
- Enhanced dehumidification achieved by pre-cooling incoming airstreams
- Installing an ACT-HP-WAHX may result in the choice of a smaller AHU
- Eliminates typical overcooling to dehumidify, plus free passive reheating of the building's entering airstream

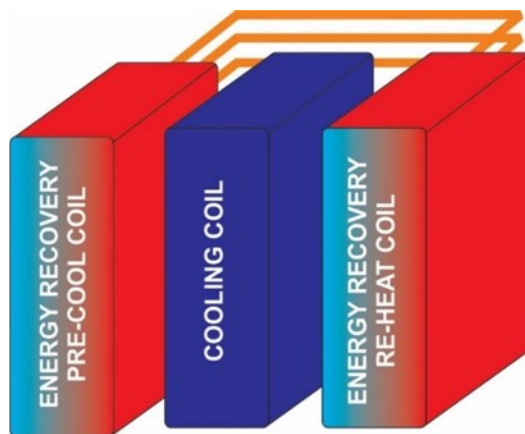

**WAHX
PIPE-TO-PIPE**

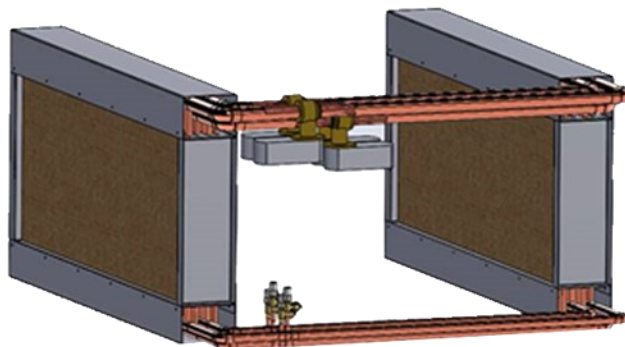

**WAHX
SPLIT LOOP**



Radiant Tube Heaters ERSP (Single Stage) & ER2STG (Two Stage)

- 10-year warranty
- Available in 10 to 60 foot system lengths
- 40,000 to 175,000 BTUs
- Aluminized 16 gauge steel tubing
- Outside or inside air for combustion
- Sealed burner control box
- Installs easily as “straight” or “U-tube”
- Full cover polished aluminum reflector
- Stainless steel couplers
- 24 volt or line voltage thermostat install option

Applications Include:

Manufacturing Plants—Truck Terminals—Repair Shops & Garages—
Warehouses—Aircraft Hangers—Fire Stations—Green Houses—Automobile
Dealerships & Body Shops—Loading Docks—Farm Buildings—Indoor Sporting
Arenas—Stables—Custom Applications

POWER VENTED UTILITY HEATERS



*50,000 BTU UTILITY HEATER SHOWN



*80,000 BTU UTILITY HEATER SHOWN



*125,000 BTU UTILITY HEATER SHOWN

HEATSTAR® UTILITY HEATERS

Designed for use in spaces adjacent to a residence. These heaters use a finer mesh fan guard and utility grade safety switches to meet the CSA Utility Heater standard.

- 50,000 to 400,000 BTU/HR

POWER VENTED UNIT HEATERS

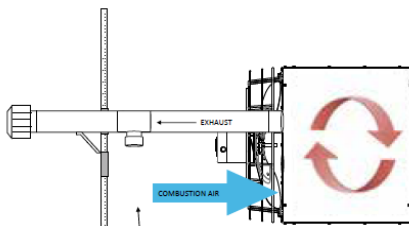

Draws in air from the space the heater is installed

- 125,000 to 400,000 BTU/HR
- Aluminized steel and stainless steel heat exchanger options



HEATSTAR® STANDARD COMBUSTION, POWER VENTED UNIT HEATERS

The fan pulls fresh air into the combustion chamber from the room air. The power vent system quickly and efficiently exhausts flue gases from the unit heater to the outdoors through a single vent pipe, minimizing installation labor.

SEPARATED COMBUSTION UNIT HEATERS

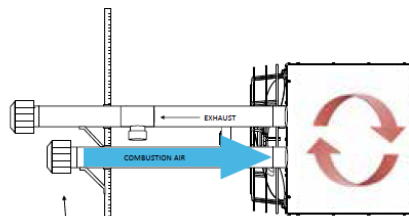

Draws in clean air from outdoors or adjacent area

- 150,000 to 400,000 BTU/HR
- Aluminized steel and stainless steel heat exchanger options



*300,000 BTU UNIT HEATER SHOWN

HEATSTAR® SEPARATED COMBUSTION UNIT HEATERS

Designed to use fresh air for combustion instead of indoor air. These heaters can also operate with a vent pipe only, in standard combustion mode, by pulling in fresh air directly from the room.



Radiant Ceiling Panels

- Largest manufacturer of radiant ceiling panels in the United States. (All raw material are USA or NAFTA origin)
- ISO 9001:2015 certified and compliant
- They offer the services of highly trained engineers and technically oriented service personal for project assistance and development
- Full sized test lab available for mock-up and real life simulation
- Proprietary rolling process that encases copper tube within housing for 300 degree metal to metal contact for the best possible heat transfer
- Large variety of colors, finishes and patterns available
- Standard 2 year warranty
- Long lasting baked enamel finish which allows easy cleaning
- 2 types: linear extruded and pre-manufactured tiles



RADIANT LINEAR EXTRUDED PANELS (AXO)

- Panel width can be fabricated from 6", 8" or 9" or any combination of 6", 8" and 9" strip.
- Standard max length is 12', with length up to 16' available by special request.
- Low Pressure Drop (LPD) version available
- Face configuration of :V-groove, Fluted, Smooth
- Custom Mounting Options

RADIANT LAY-IN FORMED METAL PANELS (RLFM)

- Standard Panels in 2'x 4' or 2'x 2'
- Snap-In Option
- Perforated Panel available for excellent sound control

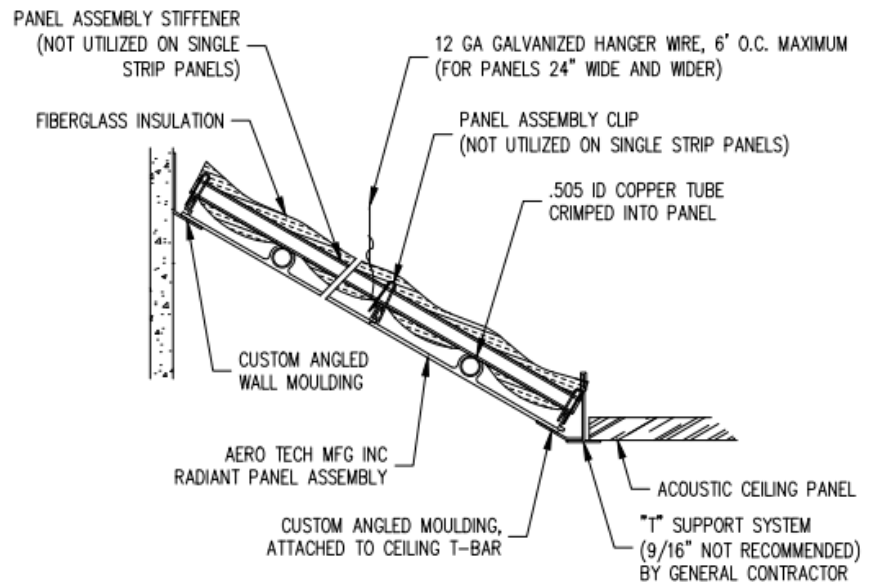
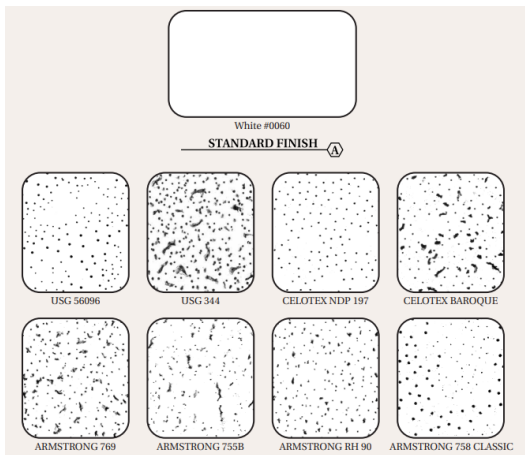

ANGLED MOUNT AND CUSTOM APPLICATION
 PANEL CAN BE MOUNTED IN A VARIETY OF CUSTOM WAYS INCLUDING, VERTICAL WALL MOUNTED AND INVERTED MOUNTING

Products

PolyGard 2 Series: Gas Detection & Control Solutions

- Economical to install
- easy to maintain SIL 2 compliance means industrial grade reliability at commercial grade cost
- X-Change sensor technology for reduced life-cycle maintenance cost Fourth generation monitoring and control functions specifically designed for global best practices
- Factory certified systems engineering for fast and easy installation and startup
- Controllers and sensors designed for the harsh garage environment: dust tight, moisture tight, and wide temperature range
- Easy connectivity to Building Automation Systems via BACnet or Modbus



Calibration Gas & Accessories



STL6



CC-,GR-,CONKIT



GC-17/58
Gas Calibration Cylinders



PX2
Multi-gas, Explosion Proof

Applications

Parking garages, tunnels, mechanical rooms, vehicle maintenance facilities, chiller plants, grow facilities, factories, schools, & pools



DGC6: Multi-Point Digital Gas Detection & Control System

Highly configurable controller for up to 96 sensors distributed on a robust RS-485 bus. Programmed with user-friendly PC software or via front panel pushbuttons, the DGC6 can be used for single- or multi-zone applications with on-off or variable speed fan controls.

SGC6: Standalone Gas Controller

Wall-mounted, NEMA 4X standalone ventilation controller with one, two, or three high-performance SC2-Series gas sensor modules. Multi-color LCD and standard horn/light module for local annunciation of escalating alarm levels.



INTEC Controls offers a complete line of sensors and controllers used with ventilation systems to prevent the dangerous accumulation of toxic gases: **carbon monoxide, nitrogen dioxide, methane, hydrogen, ammonia, refrigerant gases, carbon dioxide, volatile organic compounds (VOCs) and many more.**



VMC Group designs and custom-builds to client specifications, a vast array of supplemental bases, designed to withstand seismic and high wind forces:

- Concrete inertia bases
- Structural steel fan bases
- Rails & steel dunnage platforms
- Seismic Mounts

Signature Brands:

- Aeroflex International Isolators (Military and Aerospace)
- Amber/Booth (OEM/Commercial Spring/Elastomeric/Seismic Isolators)
- Korfund Dynamics (Industrial/OEM Spring and Elastomeric Isolators)
- Vibration Mounting & Controls (VMC)

Elastomeric Mounts

VMC Group limits the transmission of structure-borne vibrations and impacts by manufacturing an extensive range of elastomeric isolation mounts and pads

- Floor Mounted
- Ceiling Mounted
- Wall Mounted



Spring Mounts

Our broad range of spring isolation mountings and hangers limit the transmission of vibration, impact and noise over a variety of applications, from engine gensets and small fans to heavy-duty industrial equipment and HVAC equipment

- Floor Mounted
- Ceiling Mounted



Supplemental Bases

VMC Group designs and custom-builds to exacting client specifications a vast array of supplemental bases designed to withstand seismic and high wind forces:

- Concrete Inertia Bases
- Structural Steel Fan Bases
- Roof Curbs
- Rails and Steel Dunnage Platforms



Architectural Mounts

VMC Group offers a wide range of architectural isolation products to control noise and vibration disturbances throughout a building structure caused by:

- Mechanical or HVAC Equipment
- Subway Trains
- Highway Traffic
- Other Low-to-mid Frequency Range Energy Sources



APPROXIMATE MOTOR AMPERE RATING: 60 CYCLE A.C.							
HP	RPM	SINGLE PHASE		THREE PHASE			
		115v	230v	200v-208v	220v-230v	440v-480v	480v
1/40	1050	1.20					
1/20	1550	1.86					
1/10	1550	3.00					
1/12	1725	3.20	1.60				
	1140	3.20	1.60				
	860	3.20	1.60				
1/8	1725	3.00	1.50				
	1140	3.80	1.90				
	860	4.60	2.30				
1/6	1725	4.40	2.20				
	1140	5.20	2.60				
	860	5.80	2.90				
1/4	1725	4.80	2.40	1.60	1.40	0.70	0.46
	1140	5.30	2.65	1.60	1.40	0.70	0.64
	860	6.50	3.25	2.40	2.00	0.70	0.83
1/3	1725	6.00	3.30	1.80	1.60	0.80	0.73
	1140	6.60	3.30	1.70	1.60	0.80	0.73
	860	7.40	3.70	2.5	2.4	1.2	1.10
1/2	1725	9.00	4.50	2.90	2.2	1.10	0.92
	1140	9.60	4.80	3.00	2.60	1.30	1.10
	860	9.80	4.90	2.80	2.60	1.30	1.20
3/4	1725	8.40	5.80	3.60	3.10	1.50	1.38
	1140	11.60	4.20	2.60	3.40	1.70	1.10
	860	14.20	7.10	3.80	3.60	1.80	1.65
1	1725	13.80	6.90	4.20	3.40	1.70	1.56
	1140			4.40	3.80	1.90	1.74
	860			4.90	4.60	2.30	2.11
1 1/2	1725	18.00	9.00	5.60	4.80	2.40	2.20
	1140			5.10	4.80	2.40	2.20
	860			7.20	6.80	3.40	3.12
2	1725	22.00	11.00	7.10	6.20	3.10	2.57
	1140			7.20	6.80	3.40	3.12
	860			8.50	8.00	4.00	3.67
3	1725			9.30	9.20	4.60	3.67
	1140			10.30	8.80	4.40	4.03
	860			10.60	9.40	4.70	4.31
5	1725			16.20	14.20	7.10	5.96
	1140			15.20	14.4	7.20	6.60
	860			17.40	16.4	8.20	7.52
7 1/2	1725			21.20	20.80	10.40	10.80
	1140			22.00	20.00	10.00	9.17

METRIC CONVERSION FACTORS		
MULTIPLY	BY	TO OBTAIN
Btu/hr	0.293	Watts
EDR hot water (150 Btu/hr)	44.0	Watts
EER	0.293	COP
Ft ³ /min, cfm	0.472	L/s
gallon (U.S. 231 in ³)	3.79	L
GPM	0.0631	L/s
grain (1/7000 lb)	0.0648	g
inch	25.4	Mm
in of mercury (60°F)	3.38	kPa
in of water (60°F)	249	Pa
in ²	645	mm ²
in ³ (volume)	16.4	mL
lb (mass)	0.454	Kg
lb (mass)	454	g
psi	6.89	kPa
quart (liquid U.S.)	0.946	L

SUGGESTED AIR CHANGES			
TYPE OF BUILDING	MIN/AIR CHANGE	TYPE OF BUILDING	MIN/AIR CHANGE
Assembly Hall	3-10	Laundry Mat	2-5
Auditorium	4-15	Locker Room	2-5
Bakery	1-3	Machine Shop	2-5
Bank	3-10	Mill (Paper)	2-3
Bar	2-4	Mill (Textile)	5-15
Beauty Salon	2-5	Office	2-8
Boiler Room	2-4	Packing House	2-5
Bowling Alley	2-8	Production Room	1-2
Church	4-15	Projection Room	1-3
Corridors	6-20	Recreation Room	2-8
Dry Cleaner	1-5	Residence	2-5
Engine Room	1-1 1/2	Restaurant	5-10
Factory (Gen. Vent.)	5-10	Retail Store	3-10
Factory (Fumes)	1-5	Sales Room	3-10
Forge Shop	1-2	Shop (Gen. Vent.)	3-10
Foundry	1-4	Store	5-10
Garage (Repair)	2-10	Theatre	3-8
Generating Room	2-5	Toilet	2-5
Glass Plant	1-2	Transformer Room	1-5
Gymnasium	2-10	Turbine Room (Elec.)	2-6
Heat Treatment	1/2-1	Waiting Room	10
Kitchen	1-3	Warehouse	2-10

VENTILATION RATE: CFM REQUIRED FOR DESIRED AIR CHANGE

$$CFM = \frac{\text{Building Volume in Cubic Feet}}{\text{Minute/Air Change}}$$

GPM: WATER QUANTITY REQUIRED FOR HEATING AND COOLING

$$GPM = \frac{\text{Total load (Btu/hr)}}{500 \times \text{water temperature difference}}$$

LIQUID CHILLER CAPACITY IN TONS

$$\text{Capacity} = \frac{GPM \times \text{water temperature difference}}{24}$$

Btu (BRITISH THERMAL UNIT)

The amount of heat required to raise the temperature of one pound of water 1° F or the amount of heat removed in cooling one pound of water 1° F.

1 ton of refrigeration = 12,000 Btu/hr - 200 Btu/min

The amount of heat required to melt one ton of ice in 24 hours.

TOTAL AIR CONDITIONING LOAD

Sensible cooling load + Latent cooling load

$$\text{Total Load (Btu/hr)} = \text{Air volume (cfm)} \times 4.5 (h1 - h2)$$

h1 = total heat at entering WB temperature
h2 = total heat at leaving WB temperature

$$\text{Sensible load (Btu/hr)} = \text{Air volume (cfm)} \times 1.08 \times \Delta T$$

ΔT = difference between entering and leaving DB temperature.

Air Distribution



Fans & Ventilation



Duct Components



Duct Systems



Electric Heat



Sound Attenuation



Parking Garage Ventilation





DECKMAN COMPANY

**(Volume II)
1200 Cuddy Lane
Cuddy, PA 15031**

**Phone: (412) 257-3333
Website: www.deckmanco.com**