



2021-22

STOCK CATALOG

Deckman
company
COMMERCIAL HVAC WAREHOUSE

Deckman

company

COMMERCIAL HVAC WAREHOUSE

Thank you for your interest in Deckman Company and our Stock Catalog.

Deckman Company is a locally owned and operated manufacturer's representative and a stocking distributor of HVAC equipment. For 100-years, we have provided customers with a vast array of products, from our Fan & Roof Equipment and Air Distribution lines to our Duct, Pipe & Fittings, Dampers and Sheet Metal Accessories.

We take pride in the quality of the products we represent, and we stand by our commitment to provide outstanding service and assistance. Deckman Company has and always will look forward to building long-term relationships with all our customers.

Our stock catalog provides a quick and easy access to all the materials available in our warehouse. Please contact us should you need more information on any of these products or if you have inquiries about our Sheet Metal or Mechanical Division.

(412) 257-3333 or sales@deckmanco.com



FAN & ROOF EQUIPMENT



AIR DISTRIBUTION



DUCT, PIPE & FITTINGS



DAMPERS & ACCESSORIES

TABLE OF CONTENTS

ACCESS DOORS			
BASIC	16	FANS & ACCESSORIES	
FIRE RATED	16	PCV50/80 CEILING FANS	32
SANDWICH	16	L-SERIES CEILING FANS	32
HINGE & CAM	16	SPEED CONTROLLER	33
CAM LATCH	16	INLINE-ADAPTOR	33
CAM PRESS-ON	16	LED LIGHTING KIT	33
		BRICK VENTS	33
		ROOF CAPS	33
		WALL CAPS	33
ADHESIVES & DUCT SEALANTS		DOMEX (DX) ROOF FAN	34
EVERSEAL	14	ROOF CURBS	35
QUICK-STICK	14	EQUIPMENT RAILS	35
ALUMA-GRIP	14	PIPE PORTAL SYSTEM	35
FOIL-GRIP	14	DECKMATE	35
GECKO GLUE LINER ADHESIVE	14	ALUMA FLASH	35
PROSEAL	14		
SURE-GRIP 404	15	FLEXIBLE DUCT	
PROGUARD	15	INSULATED	10
STRIPPER SPRAY MAINTENANCE	15	NON-INSULATED	11
		CLAMPS	11
B-VENT & FITTINGS		DYN-O-TIE FLEX TIE	11
PIPE	17	TENSION TOOL	11
ELBOWS	17		
TEE	17	GRILLES & REGISTERS AND ACCESSORIES	
TEE CAP	17	5DMGDU	21
AMERI-CAP	17	880H	22
FITTINGS	17	S80H	23
		S80H1FF	24
CEILING DIFFUSERS		SIGHT-GUARD	24
1450	18	EG-5	24
SH	18	ECPC	24
PLQ	19	EGC-5	24
6604	19	ECRD	24
6690	19	PRN100	25
6790	19	OBDF A	25
1975	20	PR12	25
PTBSI	20	OBD	25
RM1	21	SRAC25	25
		5HCF23	25
DAMPERS & ACCESSORIES		THIN LINE CLIP	25
DYNAMIC RATED	27	PAINT	25
DYNAMIC ROUND	27		
CEILING RADIATION	27	HANGING SYSTEM, DUCT HARDWARE	
ROUND CEILING RADIATION	27	CLUTCHER SYSTEM	12
FUSIBLE LINKS	27	HANGER STRAP	12
RADIATION BLANKETS	27	DYNA-TITE SUSPENSION SYSTEM	12
CONTROL	28	DYNA-TIE CABLE & LOCKS	12
BACKDRAFT	28	ISOLATION HANGER	12
ACTUATORS	28	POLYARMOR	12
		VARIOUS ACCESSORIES	12
DUCT CONNECTION SYSTEM			
D25/35	4	LOUVERS & BRICK VENTS	
VARIOUS ACCESSORIES	4	STATIONARY LOUVER	29
TDC/TDF CORNERMATIC CORNER	5	BRICK VENT	29
TDC/TDF MANUAL CORNER	5		
VERSA CLEAT	5	MANUFACTURER OFFERINGS	36
STICKY TAPE	5		
SLIPS & DRIVES	5		
PROFLEX DUCT CONNECTOR	5		
PRORAIL & TURNING VANE	5		
		RADIANT TUBE HEATING	
		BURNER BOX	30
		TUBE SET	30
		U-TUBE	30
		INSTALLATION KIT	30
		SEASONAL PROMOTIONS	30
		SNAPLOCK PIPE & FITTINGS	
		SNAP LOCK PIPE	6
		90° ADJUSTABLE ELBOW	6
		TEE	6
		T-CAP	6
		REDUCER	6
		DAMPER BLADE	6
		SPIRAL PIPE & FITTINGS	
		SPIRAL PIPE	8
		90° ELBOW	8
		PLUG	8
		COUPLING	8
		SADDLE TAP	9
		REDUCER	9
		PRESS-ON SADDLE	9
		5DMGDU	21
		TAKE-OFF FITTINGS	
		START COLLAR	7
		PRESS-ON COLLAR	7
		HETO	7
		BELLMOUTH	7
		TERMINAL AIR UNITS	
		LMHS BOX	26
		HOT WATER COILS	26
		ULTRAVIOLET LIGHT	
		REPLACEMENT LAMPS	31
		V-MAX AIR DISINFECTION SYSTEM	31
		V-MAX COIL CLEANING SYSTEM	31



D25/35 DUCT CONNECTION SYSTEM

- System consists of roll-formed flanges, corner pieces, cleats and gasket
- Patented down set in corner insures proper sealing
- Patented corner clips ease installation
- Sealing materials meet NFPA 90A & B Class 1 requirements

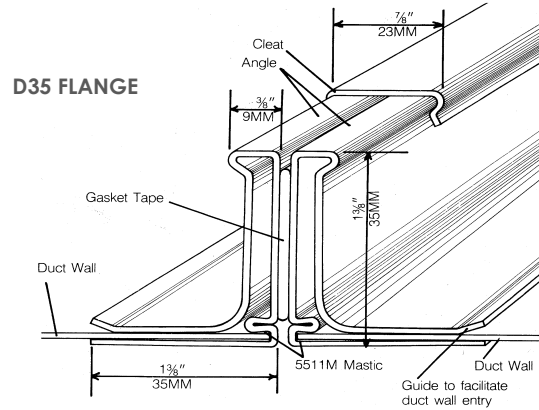
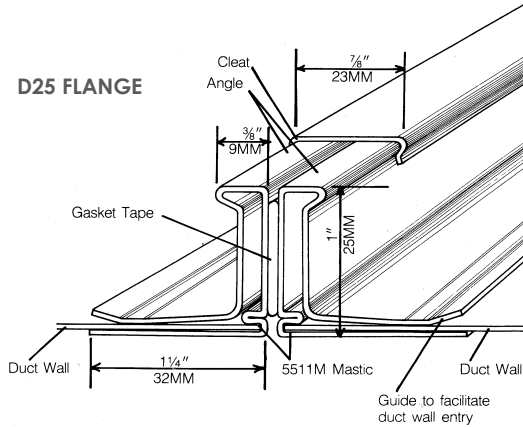

D25 CORNER W/NUT & BOLT

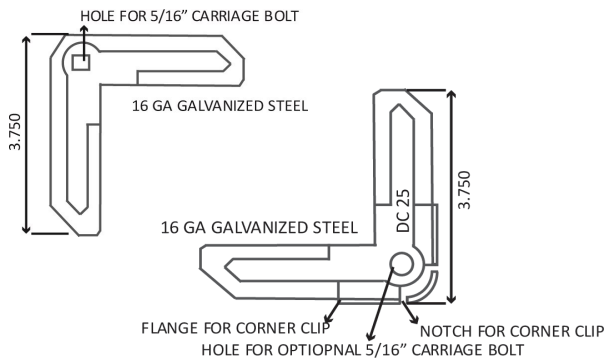

D25 CORNER W/CLIP

D35 CORNER

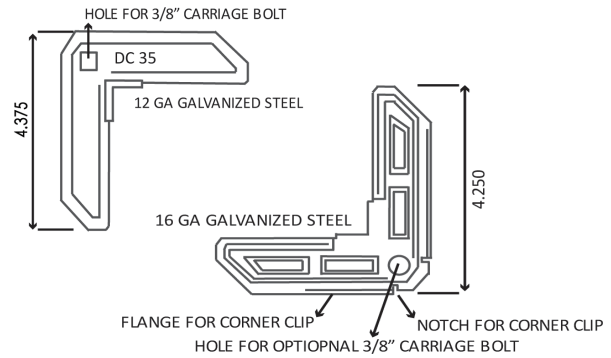

D35 CORNER W/CLIP

MODEL	PART #	GA	DESCRIPTION	QTY/SOLD BY	PRICE
D25 Flange	D2510GA	24	Galvanized steel with integral sealant	20' Piece	
D25 Corner w/Nut & Bolt	DBJRG	16	Galvanized steel with hole for 5/16" carriage bolt	250/Box	
D25 Corner w/Clip	DJRGA	16	Galvanized steel with notch for corner clip	250/Box	
D35 Flange	D3510GA	20	Galvanized steel with integral sealant	20' Piece	
D35 Corner	DC35GA	12	Galvanized steel with hole for 3/8" carriage bolt	200/Box	
3/8" Nut & Bolt	CBGA	16	Nut and bolt for D35 Corner	125/Bag	
D35 Corner w/Clip	D3BGA	16	Galvanized steel with notch for corner clip	250/Box	
6" Metal Cleat	D6CGA	20	Galvanized steel, rolled form, 6" piece	500/Box	
PVC Cleat	6" PVC		Use around perimeter of transverse joint, 6" piece	6" Piece	
440 Gasket	440 3/16" x 5/8"		Non-hardening, extruded butyl tape	25' Roll	
Neoprene Gasket	NEO 5/16" x 3/4"		Synthetic, closed cell, rubber based sealing tape	50' Roll	
Nylon Nut & Bolt	HEXBN38NY		Nylon nut and bolt	Each	
Repeater Nails	RPF3000		3/4" - 1" length, helical/gripshank, smooth wire-collated coil nails	3,000/Box	

Duct Connection System & Accessories

TDC/TDF Corner, Versa-Cleat, Sticky Tape, Slips and Drives, ProFlex, ProRail



DUCT, PIPE & FITTINGS

TDC / TDF CORNERMATIC CORNER

- Hole for 3/8" carriage bolt
- Use with automatic corner inserter machine

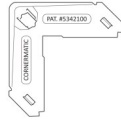

TDC / TDF MANUAL CORNER

- Hole for 3/8" carriage bolt
- Manual insertion only

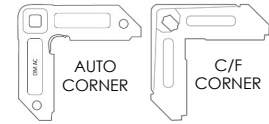

PRODUCT INFORMATION				
MODEL	PART #	GA	QTY/SOLD BY	PRICE
TDC	CMCGA	16	250/Box	
TDF	CMFGA	16	250/Box	
TDC*	CMCGASTPR	16	400/Box	
TDF*	CMFGASTPR	16	400/Box	

PRODUCT INFORMATION				
MODEL	PART #	GA	QTY/SOLD BY	PRICE
TDC	ACGA	16	250/Box	
TDF	CMFGAMI	16	250/Box	
TDF	CMCGAMI	16	250/Box	

*FOR USE WITH CORNERMATIC MACHINE

VERSA CLEAT / STICKY TAPE

- 6" Snap-on cleat
- 3/8" x 3/8" Butyl gasket tape



SLIPS & DRIVES

- Standard connectors
- Ridged
- Leak-proof

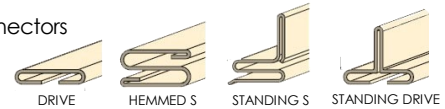

PRODUCT INFORMATION				
MODEL	PART #	GA	QTY/SOLD BY	PRICE
VERSA Cleat	DV6CGA	22	250/Box	
Sticky Tape	N/A	N/A	25' Roll	

PRODUCT INFORMATION & DIMENSIONS				
MODEL	SIZE	GA	QTY/SOLD BY	PRICE
Drive	1.125"	24	10' Piece	
Hemmed S	1.125"	24	10' Piece	
Standing S	1.125" x 1"	24	10' Piece	
Standing Drive	1.25" x 1"	24	10' Piece	

PROFLEX DUCT CONNECTOR

- Airtight and waterproof
- Commercial or residential
- Double-lock gripping fingers of metal to fabric adds to holding power
- Meets NFPA 90A & 90B specifications
- Pre-assembled with sheet metal permanently secured to fabric
- Fabrics are NFPA 701 listed

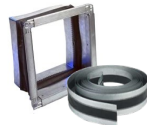

PRORAIL & TURNING VANE

- Tabs friction-fit into double-wall turning vane to ensure connection up to 57 lbs. of pull-out force per tab
- Precision stamped galvanized steel
- Pressure tested to 15" wg
- Tabs secure vane to avoid misalignment



PRODUCT INFORMATION & DIMENSIONS				
MODEL	MATERIAL	GA	QTY/SOLD BY	PRICE
1.25" x 3" x 1.25"	Vinyl	24	100' Box	
3" x 3" x 3"	Vinyl	24	100' Box	
4" x 4" x 4"	Vinyl	24	100' Box	
3" x 3" x 3"	Neoprene	24	100' Box	
4" x 4" x 4"	Neoprene	24	100' Box	

PRODUCT INFORMATION & DIMENSIONS				
SIZE	PART #	GA	QTY/SOLD BY	PRICE
2" Vane	2VGA26	26	10' Piece	
2" Rail	2PRGA22	22	10' Piece	
4" Vane	2VGA24	24	10' Piece	
4" Rail	4PRGA22	22	10' Piece	

GreenSeam Plus Snap Lock Pipe & Fittings

Pipe, Adjustable Elbow, Tee, T-Cap, Reducer, Damper Blade



SNAP LOCK PIPE

- Designed and tested to surpass SMACNA Class 3 Leakage Standards
- Galvanized steel (ASTM A653 and A924)
- 26 GA, G-60 galvanized coating (ASTM A653 and ASTM A90)
- Button lock pipe meets SMACNA RL-8
- Pressure rating -1" wg to +2" wg
- Transverse & longitudinal seam is pre-sealed with gasket



PRODUCT DIMENSIONS				
SIZE	26 GA		24 GA	
	24"	60"	24"	60"
4"				
5"				
6"				
7"				
8"				
9"				
10"				
12"				
14"				
16"				

90° ADJUSTABLE ELBOW

- Galvanized steel (ASTM A653 and A924)
- 26GA, G-60 galvanized coating (ASTM A653 and ASTM A90)
- Pressure rating -1" wg to +2" wg
- Dimensional tolerance: ± 1/4"



PRODUCT DIMENSIONS				
SIZE	GA	PRICE	GA	PRICE
4"	26		24	
5"	26		24	
6"	26		24	
7"	26		24	
8"	26		24	
9"	26		24	
10"	26		24	
12"	26		24	
14"	26		24	
16"	26		24	

TEE / T-CAP

- Galvanized steel (ASTM A653 and A924)
- 26GA, G-60 galvanized coating (ASTM A653 and ASTM A90)
- Pressure rating per SMACNA Third Edition 2005 section 4.8 figure 4-6 Branch Connections
- Dimensional tolerance: ± 1/4"
- Pre-sealed with gasket



PRODUCT DIMENSIONS				
SIZE	TEE		T-CAP	
	GA	PRICE	GA	PRICE
4"	26		26	
5"	26		26	
6"	26		26	
7"	26		26	
8"	26		26	
9"	26		26	
10"	26		26	
12"	26		26	
14"	26		26	
16"	26		26	

REDUCER / DAMPER BLADE

- Galvanized steel (ASTM A653 and A924)
- 26GS, G-60 galvanized coating (ASTM A653 and ASTM A90)
- Pressure rating per SMACNA Third Edition 2005 section 4.8 figure 4-6 Branch Connections
- Dimensional tolerance: ± 1/4"
- Damper Blade: 24 GA, G-60 galvanized steel



PRODUCT DIMENSIONS					
REDUCER			DAMPER		
SIZE	GA	PRICE	SIZE	GA	PRICE
4" x 3"	26		4"	24	
5" x 4"	26		5"	24	
6" x 4", 6" x 5"	26		6"	24	
7" x 6", 7" x 5"	26		7"	24	
8" x 7", 8" x 6"	26		8"	24	
9" x 8"	26		9"	24	
10" x 9"/8"/7"/6"	26		10"	24	
12" x 10"/8"/6"	26		12"	24	
14" x 12", 14" x 10"	26		14"	24	
16" x 14"	26		16"	24	

DIMENSIONS SHOWN ARE DUCT SIZE X TAP SIZE

Take-Off Fittings

Start Collar, Press-On, HETO, Bellmouth



DUCT, PIPE & FITTINGS

START COLLAR

- Designed and tested to surpass SMACNA Class 3 Leakage Standards
- Galvanized steel (ASTM A653 and A924)
- 26 GA, G-60 galvanized coating (ASTM A653 and ASTM A90)
- Dimensional tolerance: $\pm 1/4$ "
- Pre-sealed with gasket



PRODUCT DIMENSIONS			
SIZE	GA	BOX QTY	PRICE EACH
4"	26	30	
5"	26	30	
6"	26	20	
7"	26	20	
8"	26	20	
9"	26	20	
10"	26	20	
12"	26	10	
14"	26	10	
16"	26	5	
18"	26	5	
20"	26	5	

PRESS-ON COLLAR WITH OR WITHOUT DAMPER

- Designed and tested to surpass SMACNA Class 3 Leakage Standards
- Galvanized steel (ASTM A653 and A924)
- 26 GA, G-60 galvanized coating (ASTM A653 and ASTM A90)
- Dimensional tolerance: $\pm 1/4$ "
- Pre-sealed with gasket



PRODUCT DIMENSIONS				
SIZE	GA	BOX QTY	PRICE EACH w/DAMPER	PRICE EACH w/o DAMPER
4"	26	25		
5"	26	25		
6"	26	20		
7"	26	20		
8"	26	20		
9"	26	10		
10"	26	10		
12"	26	10		
14"	26	5		
16"	26	5		
18"	26	5		
20"	26	2		

HETO WITH DAMPER AND/OR WITH STAND-OFF

- Designed and tested to surpass SMACNA Class 3 Leakage Standards
- Galvanized steel (ASTM A653 and A924)
- 26 GA, G-60 galvanized coating (ASTM A653 and ASTM A90)
- Dimensional Tolerance: $\pm 1/4$ "
- Pre-sealed with gasket



PRODUCT DIMENSIONS			
SIZE	GA	PRICE	2" STAND-OFF PRICE
5"	26		
6"	26		
7"	26		
8"	26		
9"	26		
10"	26		
12"	26		
14"	26		
16"	26		
18"	26		
20"	26		

BELLMOUTH WITH DAMPER

- Meets SMACNA Class 3 leakage requirements
- Precision spun into one piece of galvanized steel
- Pressure rating -2" wg to +10" wg



PRODUCT DIMENSIONS		
SIZE	GA	PRICE
6"	20	
7"	20	
8"	20	
9"	20	
10"	20	
12"	20	
14"	20	
16"	20	

Spiral Pipe & Fittings

Pipe, Elbow, Plug, Coupling

SPIRAL PIPE

- Single wall
- Galvanized steel (ASTM A653 and A924)
- G-60 galvanized coating (ASTM A653 and ASTM A90)



PRODUCT DIMENSIONS			
SIZE	LENGTH	GA	PRICE
4"	10'	26	
5"	10'	26	
6"	10'	26	
7"	10'	26	
8"	10'	26	
9"	10'	26	
10"	10'	26	
12"	10'	26	
14"	10'	26	
16"	10'	24	
18"	10'	24	
20"	10'	24	

SEE PAGE 21 FOR SPIRAL DUCT MOUNTED GRILLES

90° OR 45° ELBOW

- Galvanized steel
- Gasketed
- Gore locked seams
- 1.5 centerline radius



PRODUCT DIMENSIONS				
SIZE	90°		45°	
	GA	PRICE	GA	PRICE
4"	26		24	
5"	26		24	
6"	26		24	
7"	26		24	
8"	26		24	
9"	26		24	
10"	26		24	
12"	26		24	
14"	26		24	
16"	24		24	
18"	24		24	
20"	24		24	

PLUG

- Galvanized steel
- Gasketed
- Internal working pressure: +10" wg



PRODUCT DIMENSIONS		
SIZE	GA	PRICE
4"	26	
5"	26	
6"	26	
7"	26	
8"	26	
9"	26	
10"	26	
12"	26	
14"	26	
16"	24	
18"	24	
20"	24	

COUPLING

- Galvanized steel
- Gasketed
- Internal working pressure: +10" wg



PRODUCT DIMENSIONS		
SIZE	GA	PRICE
4"	26	
5"	26	
6"	26	
7"	26	
8"	26	
9"	26	
10"	26	
12"	26	
14"	26	
16"	24	
18"	24	
20"	24	

Spiral Pipe & Fittings

Saddle Tap, Reducer, Press-on Saddle

SADDLE TAP

- Galvanized steel
- Gasketed
- Internal working pressure: +10" wg
- Branch size on pipe size listed



PRODUCT DIMENSIONS		
SIZE	GA	PRICE
4" on 5"	26	
4" on 6"/7"	26	
5" on 6"/7"	26	
6" on 8"	26	
6" on 10"/12"	26	
6" on 14"/18"	26	
8" on 10"	26	
8" on 12"/14"	26	
8" on 16"/18"	26	
10" on 12"	26	
10" on 14"/16"	26	
10" on 18"/20"	26	
12" on 14"/16"	24	
12" on 18"/20"	24	
14" on 16"	24	
14" on 18"	24	
14" on 20"	24	
16" on 18"	24	
16" on 20"	24	
18" on 20"	24	

REDUCER

- Galvanized steel
- Gasketed
- Internal working pressure: +10" wg



PRODUCT DIMENSIONS		
SIZE	GA	PRICE
5" x 4"	26	
6" x 5"	26	
7" x 5"	26	
7" x 6"	26	
8" x 5"	26	
8" x 6"	26	
8" x 7"	26	
9" x 5"	26	
9" x 6"	26	
9" x 8"	26	
10" x 6"	26	
10" x 8"	26	
10" x 9"	26	
12" x 8"	24	
12" x 9"	24	
12" x 10"	24	
14" x 10"	24	
14" x 12"	24	
16" x 12"	24	
16" x 14"	24	
18" x 16"	24	
20" x 16"	24	
20" x 18"	24	

PRESS-ON SADDLE WITH DAMPER

- Galvanized steel
- Gasketed
- Branch size on pipe size listed



PRODUCT DIMENSIONS		
SIZE	GA	PRICE
6" on 6"	26	
6" on 8"-10"	26	
8" on 8"-10"	26	
8" on 10"-12"	26	
8" on 14"-16"	26	
10 on 10"-12"	26	
12" on 12"-14"	26	

Flexible Duct

Insulated: 1M, 3M, 070, 036



INSULATED - 1MR6

- UL181, Class 1 Air Duct
- Acoustical application
- Polyethylene fabric
- Corrosive resistant galvanized steel helix
- Fire retardant, reinforced aluminum material
- Fiberglass insulation
- 10" wg positive working pressure



PRODUCT DIMENSIONS		
SIZE	LENGTH PER BOX	PRICE
4"	25'	
6"	25'	
8"	25'	
9"	25'	
10"	25'	
12"	25'	
14"	25'	
16"	25'	
18"	25'	

INSULATED - 3M R6

- UL181, Class 1 Air Duct
- Low to high pressure applications
- Aluminum foil, fiberglass and aluminized polyester trilaminate fabric
- Corrosive resistant galvanized steel helix
- Fire retardant, reinforced aluminum material
- Fiberglass insulation
- 20" wg positive working pressure



PRODUCT DIMENSIONS		
SIZE	LENGTH PER BOX	PRICE
4"	25'	
5"	25'	
6"	25'	
7"	25'	
8"	25'	
9"	25'	
10"	25'	
12"	25'	
14"	25'	
16"	25'	
18"	25'	

INSULATED - TYPE 070 R4.2

- UL181, Class 1 Air Duct
- Low to medium pressure application
- Tri-directional, scrim reinforced grey polyester vapor barrier
- Air-tight core
- 6" wg 4" thru 12" positive working pressure
- 4" wg 14" thru 20" positive working pressure

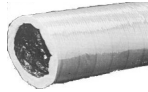

PRODUCT DIMENSIONS		
SIZE	LENGTH PER BOX	PRICE
4"	25'	
5"	25'	
6"	25'	
7"	25'	
8"	25'	
9"	25'	
10"	25'	
12"	25'	
14"	25'	
16"	25'	
18"	25'	
20"	25'	

INSULATED - TYPE 036 R6

- UL181, Class 1 Air Duct
- Low to medium pressure application
- Tri-directional, scrim reinforced grey polyester vapor barrier
- Air-tight core
- 6" wg 4" thru 12" positive working pressure
- 4" wg 14" thru 20" positive working pressure



PRODUCT DIMENSIONS		
SIZE	LENGTH PER BOX	PRICE
4"	25'	
5"	25'	
6"	25'	
7"	25'	
8"	25'	
9"	25'	
10"	25'	
12"	25'	
14"	25'	
16"	25'	
18"	25'	
20"	25'	

Flexible Duct & Accessories

Non-Insulated 055, Quick Release Clamp, DYN-O-TIE, Tension Tool



DUCT, PIPE & FITTINGS

NON-INSULATED - TYPE 055

- UL181, Class 1 Air Connector
- Low to medium pressure application
- Metallized polyester, aluminum foil and polyester triple lamination
- Air-tight non-insulated core
- 10" wg positive working pressure



PRODUCT DIMENSIONS		
SIZE	LENGTH PER BOX	PRICE
4"	25'	
5"	25'	
6"	25'	
7"	25'	
8"	25'	
9"	25'	
10"	25'	
12"	25'	
14"	25'	
16"	25'	
18"	25'	
20"	25'	

QUICK RELEASE CLAMP

- Band and housing are AISI 201 stainless steel
- Screw made of AISI 1018 carbon steel
- Bridge is AISI 410 stainless steel



PRODUCT DIMENSIONS					
MODEL	FLEX SIZE	CLAMP MIN.	DIAMETER MAX	LENGTH	PRICE
LS-152	9"	2"	10"	32"	
LS-232	12"	10"	14"	48"	

DYN-O-TIE

- For use with high or low pressure flex, insulated or non-insulated flex and positive or negative pressure systems



PRODUCT DIMENSIONS					
MODEL/LENGTH	WITH LINER	OVER INSULATION	SAME SIZE TOGETHER	QTY/SOLD BY	PRICE EACH
DDN-36"	36"	10"	17"	50/Bag	
DDN-48"	48"	14"	25"	50/Bag	

TENSION TOOL

- Nonmetallic clamps
- 120 lbs. to 175 lbs. duct straps



PRODUCT DIMENSIONS	
MODEL	PRICE
Tension Tool	

Hanging Systems, Duct Hardware & Accessories

Clutcher, Hanger Strap, DYNA-TITE, Isolation Hanger, PolyArmor



CLUTCHER SYSTEM

- Meets SMACNA construction standards
- Seismic tested and conforms to ICC Code guidelines AC284
- Tapered bore design
- Engineered for strength and durability
- Items can be hung at angles up to 60° from vertical



PRODUCT INFORMATION		
SIZE	QTY/SOLD BY	PRICE
CL 20 Clutcher	10/Bag	
WR 20500 Cable	500' Spool	
Cable Cutter	Each	

HANGER STRAP

- Convenient carrying handle
- Easy to dispense box design
- Perfect for small or difficult installations



PRODUCT INFORMATION & DIMENSIONS			
SIZE	GA	QTY/SOLD BY	PRICE
1"	22	200'/Box	
1"	24	200'/Box	
1"	26	200'/Box	

DYNA-TITE SUSPENSION SYSTEM STARTER KIT

- Galvanized steel cable wire rope
- Cable locks with pin
- CCC-1 custom cable counter lid with 5 digit counter, push button reset and lightweight bucket
- Wire rope cable cutter with spring loaded handles and hardened steel blades
- System has working load range of 25 -150 lbs.



PRODUCT INFORMATION	
MODEL	PRICE
CL12-WC3SK Starter Kit	

MANUFACTURED BY DURODYNE

DYNA-TITE CABLE WITH CABLE LOCKS

- Galvanized steel cable wire rope
- Cable locks with release pin
- Looped cable with cable lock
- System has working load range of 25 -150 lbs.



PRODUCT INFORMATION & DIMENSIONS			
SIZE	ROPE LENGTH	QTY/SOLD BY	PRICE
LC12-K10	10'	10/Bag	
LC12-K15	15'	10/Bag	

MANUFACTURED BY DURODYNE

ISOLATION HANGER

- Steel suspension bracket with rubber isolation pad
- 1100 lbs. maximum load-bearing capacity
- For 3/8" threaded rod
- Zinc Electroplated to 10-15 microns
- 75-85 Styrene-butadiene rubber
- 194° F max to -22° F min temp



PRODUCT INFORMATION & DIMENSIONS				
MODEL	OVERALL LENGTH	MAXIMUM WIDTH	QTY/SOLD BY	PRICE
DM 2723 SI	5 7/8"	1 13/16" X 1 13/16"	EACH	

POLYARMOR*

- Fiberglass free duct liner
- Hypoallergenic polyester material webbed into thermal blanket and bonded with FSK facing
- Excellent sound absorption and durability in the airstream
- R-4.2 (nom. 1"), R-5 (nom. 1 1/4") R-6 (nom. 1 1/2") and R-8 (nom. 2") material available



*AVAILABLE ON SPECIAL ORDER. PLEASE CALL FOR DETAILS.

PRODUCT	DESCRIPTION	QTY/SOLD BY	PRICE
Damper Quad Set	3/8" single shear quadrant regulator set	1 Set	
Single Shear Damper Quad	3/8" single shear quadrant regulator only	Each	
Shaft Lock Damper Quad	1/2" shaft lock quadrant, round or square	Each	
Regulator Set	non-insulated, 1/4" square shaft dial regulators and 1/4" sets	10/Pack	
Insulated Regulator Set	insulated, 1/4" square shaft dial regulators and 1/4" sets	10/Pack	
Regulator KWIKI Set	regulator and bearing, zinc-plated, install up to 10x10 damper	10/Pack	
FSK DUCT Wrap	1 1/2" thick, aluminum foil duct wrap	100' Roll	
FSK Tape	3" W x 150' tape, foil/scrim/kraft lamination, acrylic adhesive	150' Roll	
1/2" Weld Pins	1/2" weld pins for 1/2" duct liner	5,000/Box	
3/4" Weld Pins	3/4" weld pins for 1" duct liner	5,000/Box	
1" Weld Pins	1" weld pins for 1 1/2" duct liner	5,000/Box	
HIGH-HEAD PRO Point Screws	#10 HH X 3/4" self drilling screw	5,000/Box	

Adhesives & Duct Sealants

EverSeal, Quick-Stick, Aluma-Grip, Foil-Grip, Gecko Glue, ProSeal



EVERSEAL

- Water based
- Indoor/outdoor grade
- For applications up to 10" wg
- Smooth application, remains flexible
- UL 181B-M Listed
- UL 723 Classified
- LEED® Compliant



PRODUCT DIMENSIONS		
SIZE	QTY/SOLD BY	PRICE
11 OZ. Tubes	Each	
1 Gallon Bucket	Each	

QUICK-STICK

- Pressure sensitive, methylene chloride based, high solids content
- Easy application, extremely quick tack and strong permanent bond
- Meets DOT 39 NRC
- Non-Flammable in wet and dry state
- LEED® Compliant



PRODUCT DIMENSIONS		
SIZE	QTY/SOLD BY	PRICE
13 OZ. Can	Each	
40 Pound Cylinder	Each	

ALUMA-GRIP AFT-701

- 40-Year cycle, indoor/outdoor use
- Heavy pressure, pressure sensitive
- Immediate seal, long term adhesion
- 30-mil thickness
- True Zero-VOC, zero dry time
- LEED® Compliant
- Aggressive water-resistant grip to sheet metal, duct board, flex duct, PVC coated duct and duct wrap vapor barriers



PRODUCT DIMENSIONS		
SIZE	QTY/SOLD BY	PRICE
3"	50' Roll	

FOIL-GRIP AFG-1404-181BX

- 40-Year cycle, indoor/outdoor use
- Pressures sensitive rolled mastic sealant
- Foil faced/butyl adhesive composite
- Immediate air-tight bond
- 17-mil thickness
- True Zero-VOC, zero dry time
- Superior tack for galvanized metal, flex duct, PVC coated pipe and ductwork
- UL 181B-FX listed



PRODUCT DIMENSIONS		
SIZE	QTY/SOLD BY	PRICE
3"	100' Roll	

GECKO GLUE GOLD

- Water based
- Fast tacking
- Black in color
- Non-flammable in wet and dry areas
- Smooth application, remains flexible
- Solvent free
- UL Classified
- LEED® Compliant



PRODUCT DIMENSIONS		
SIZE	QTY/SOLD BY	PRICE
5 Gallon Pail	Each	

PROSEAL

- Indoor/outdoor grade
- Water based
- For applications up to 15" wg
- Low brush drag and spreadability
- Permanent seals metal duct systems
- Highly crack resistant and flexible
- UL 181B-M Listed, UL 723 Classified
- LEED® Compliant



PRODUCT DIMENSIONS		
SIZE	QTY/SOLD BY	PRICE
11 OZ. Tubes	Each	
1 Gallon Bucket	Each	

SURE-GRIP 404

- Solvent based, fiber-free, synthetic rubber duct sealant
- Exceptional strength, fast drying, flexible
- Low velocity, no-drip, no-string formula
- SMACNA ½, 1, 2, 3, 4, 6, and 10" WG
- UL 181B-M listed
- Meets seal class A



PRODUCT DIMENSIONS		
SIZE	QTY/SOLD BY	PRICE
11 OZ. Tubes	Each	

PROGUARD

- Single-ply polyethylene film
- Medium tack
- Elongation up to 600%
- Excellent strength
- Leaves no sticky residue on ductwork
- Convenient pliability



PRODUCT DIMENSIONS		
SIZE	QTY/SOLD BY	PRICE
24"	200' Roll	
36"	200' Roll	
48"	200' Roll	

STRIPPER SPRAY MAINTENANCE

- De-galvanizing agent strips galvanized build-up from metal forming machines and press dies



PRODUCT DIMENSIONS		
SIZE	QTY/SOLD BY	PRICE
15 OZ. Canister	Each	

Access Doors

Basic, Fire Rated, Round Spiral, Hinge & Cam, Cam Latch

BASIC

- 18 GA steel door
- 18 GA steel trim
- Stainless steel flush cam latch
- Pin hinge top and bottom
- Allows opening to 165°
- Primed White baked enamel finish
- Paintable surface



PRODUCT DIMENSIONS		
SIZE		PRICE
8" x 8"		
10" x 10"		
12" x 12"		
14" x 14"		
16" x 16"		
18" x 18"		
24" x 24"		

FIRE RATED

- 20 GA steel door
- 16 GA steel trim
- Knurled knob lock with one flush key
- Flush continuous piano type hinge
- 2" thick mineral wool insulation
- Primed White baked enamel finish
- Paintable surface



PRODUCT DIMENSIONS		
SIZE		PRICE
12" x 12"		
16" x 16"		
24" x 24"		

ROUND SPIRAL DUCT SANDWICH

- Non-insulated doors
- Precision stamped steel
- Closed cell neoprene gasket
- Tested to 20" wg with no leakage noted
- Tested to negative 10" wg with no leakage noted
- No frame to install
- Effortless opening and closing (no tools required)
- No measuring (self-adhesive template provided)



PRODUCT DIMENSIONS		
SIZE	SPIRAL DUCT SIZE	PRICE
8" x 4"	6"	
8" x 4"	8"	
12" x 8"	10"	
12" x 8"	12"	
12" x 8"	14"	
12" x 8"	16"	
16" x 12"	18"	
16" x 12"	20"	

HINGE & CAM / CAM LATCH

- Insulated
- Double gasketed
- 1" high density fiberglass insulation
- Closed cell cross-linked polyethylene gasket
- Temperature range of -70°F to 175°F
- HINGE & CAM: full length galvanized steel piano hinge is secured to both frame and door with cam latch
- CAM LATCH: 16 GA galvanized steel cam and 20 GA galvanized steel latch
- Available with press-on frame



PRODUCT DIMENSIONS			
SIZE	HINGE & CAM PRICE	CAM LATCH PRICE	CAM LATCH PRESS-ON PRICE
6" x 6"			
8" x 8"			
10" x 10"			
12" x 12"			
14" x 14"			
16" x 16"			
18" x 18"			
20" x 20"			
24" x 24"			

B-Vent & Accessories

Pipe, Elbow, Tee, T-Cap, Tall Cone, Storm Collar, Increaser, Various Accessories



DUCT, PIPE & FITTINGS

B-VENT

- Ameri-vent Type B is all-metal, double-wall gas vent listed by Underwriters Laboratories, Inc.
- Approved for residential and commercial applications such as Category 1 water heaters, boilers, furnaces, space heaters or wall heaters
- UL-approved Type B gas vent products form a continuous passageway from an approved gas appliance to the termination of the vent above the roof of the structure
- Uses a double wall of metal pipe for insulation and safety
- Inner pipe of reflecting aluminum heats quickly, containing the warm flue gases inside
- Air space between inner and outer pipes provides insulation against heat loss to keep warmer flue gases on the rise
- Outer pipe of corrosion-resistant galvanized steel insures strength, safety and durability
- Adaptors are universal for use with other manufacturer's double-wall B-vent

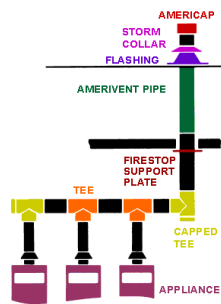

TYPICAL INSTALLATION

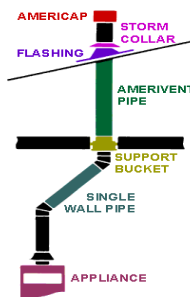

SINGLE INSTALLATION

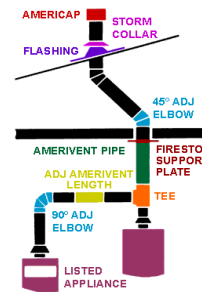

MULTIPLE INSTALLATION

PRODUCT DIMENSIONS

B-VENT AND COMPONENTS	3"	4"	5"	6"	8"
5' Long Pipe					
4' Long Pipe					
3' Long Pipe					
24" Long Pipe					
18" Long Pipe					
12" Long Pipe					
12" Long Adjustable Pipe					
90 Adjustable Elbow					
45 Adjustable Elbow					
Tee					
Tee Cap					
Draft Hood Connector					
Ameri-Cap					
Standard Flashing 5" High					
Tall Cone 12" High					
Storm Collar					
Firestop					
Firestop Support					
Female Adaptor					
Male Adaptor					
Bucket Support					
Bucket Hanger					
Increaser					

NOTE (1) 3"-7" SIZES O.D. EQUALS I.D. +1/2", (2) 8"-14" SIZES O.D. EQUALS I.D. +1", (3) STD FLASHING FLAT TO 6/12 PITCH, (4) TALL CONE FLASHING TO 1/12 PITCH

Ceiling Diffusers

1450, SH



1450 - STEEL LOUVERED FACE DIFFUSER WITH 3-CONES

- 3 cones for optimum airflow control
- 1-piece stamped construction cone without mitered joints
- Round inlet for easy connection
- Anti-smudge design prevents smeared ceilings
- Two earthquake tabs are standard
- Steel construction
- Standard finish is British White

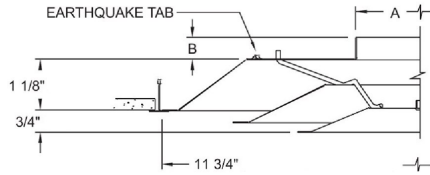

FRAME 22, SURFACE MOUNT, 12" x 12"

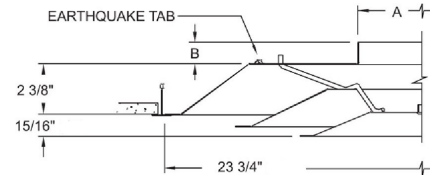

FRAME 23, LAY-IN, T-BAR, 24" x 24"

PRODUCT INFORMATION & DIMENSIONS						FRAME DIMENSIONAL DATA		
NECK SIZE	CFM @ NC-35	FRAME 22 SURFACE MT 12" x 12"	FRAME 23 LAY-IN 24" x 24"	SURFACE FRAME 24" X 24"	PRN100	NECK SIZE	FRAME 22 AND FRAME 23	
							A	B
6"	280					6"	5 7/8"	1 1/4"
8"	415					8"	7 7/8"	1 1/4"
10"	575					10"	9 7/8"	1 1/2"
12"	690					12"	11 7/8"	1 1/2"
14"	855					14"	13 7/8"	1 1/2"

SH - STEEL LOUVERED FACE DIFFUSER WITH SQUARE NECK

- Square inlet; round duct connection available
- Complete diffuser consists of frame and core
- Items stocked, shipped and sold separately
- Steel construction
- Standard finish is British White

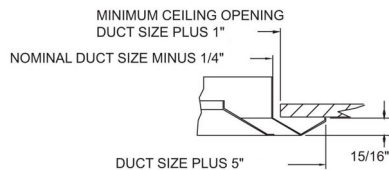
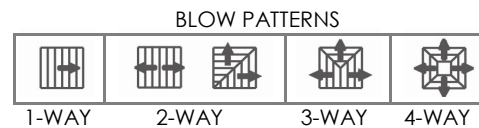

FRAME 21, SURFACE MOUNT, BEVELED

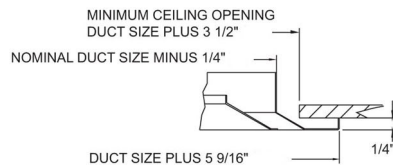

FRAME 22, SURFACE MOUNT

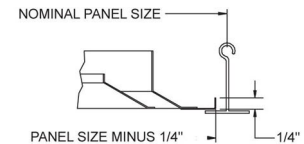

FRAME 23, LAY-IN, T-BAR

PRODUCT INFORMATION & DIMENSIONS							
NECK SIZE	CFM @ NC-35	FRAME 21 SURFACE MT BEVELED	FRAME 22 SURFACE MT	FRAME 23 LAY-IN 24" x 24"	OBDFA DAMPER	F45C SQUARE TO ROUND CONNECTION	
						SIZE	PRICE
6" x 6"	260					6" x 6" x 6"	
9" x 9"	540					9" x 9" x 6" or 8"	
12" x 12"	950					12" x 12" x 10" or 12"	
15" x 15"	1300					15" x 15" x 12" or 14"	

PLQ - STEEL DIFFUSER WITH REMOVABLE SQUARE PLAQUE FACE

- 360° radial discharge air pattern w/round inlet
- Removable square faceplate and damper
- Directional blow pattern control tabs (DBT) available
- Steel construction
- Standard finish is British White

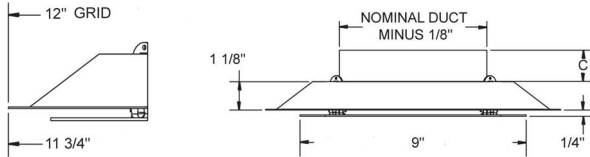

FRAME 23, LAY-IN, T-BAR, 12" x 12" / PLQ SIDE VIEW

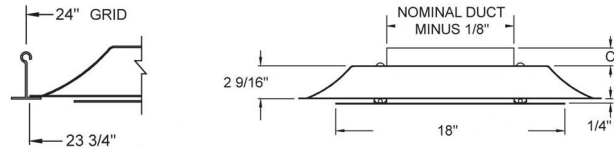

FRAME 23, LAY-IN, T-BAR, 24" x 24" / PLQ SIDE VIEW

PRODUCT INFORMATION & DIMENSIONS							SIDE VIEW DIMENSIONAL DATA			
NECK SIZE	CFM @ NC-35	FRAME 23 LAY-IN 12" x 12"	FRAME 23 LAY-IN 24" x 24"	DAMPER		DBT TABS		NECK SIZE	SIDE VIEW 12" x 12"	SIDE VIEW 24" x 24"
				PRN100	PR12	12"	24"		C	C
6"	216							6"	1 1/8"	1 1/8"
8"	365							8"	1 1/8"	1 1/4"
10"	500							10"		1 3/8"
12"	670							12"		1 3/8"
14"	855							14"		1 3/8"
15"	975							15"		1 3/8"

DBT TABS: 1-WAY REQUIRES 3 TABS; 2-WAY REQUIRES 2 TABS; 3-WAY REQUIRES 1 TAB

6604 - STEEL PERFORATED DIFFUSER

- Round inlet
- Removable perforated face
- Adjustable 1, 2, 3 or 4-way blow patterns
- Standard finish is British White



6690 - STEEL PERFORATED RETURN

- Round inlet
- Removable perforated face
- Standard finish is British White



PRODUCT DIMENSIONS			
NECK SIZE	CFM @ NC-35	DAMPERS	
		PRN100	PR12
6"	216		
8"	314		
10"	431		
12"	527		
14"	668		
16"	796		

PRODUCT DIMENSIONS			
NECK SIZE	CFM @ NC-35	DAMPERS	
		PRN100	PR12
6"	216		
8"	314		
10"	431		
12"	527		
14"	668		
16"	796		

6790 - STEEL PERFORATED RETURN PANEL

- Steel face
- For non-ducted return air systems
- Standard finish is British White



PRODUCT DIMENSIONS		
SIZE	CFM @ NC-35	PRICE
24" x 12"	819	
24" x 24"	1688	

1975 - ALUMINUM LINEAR SLOT DIFFUSER

- Extruded aluminum construction
- Adjustable, removable blades with 3/4" slot width
- End borders faceted with end cap
- Frame style accommodates lay-in or surface mount
- Matching insulated boot plenum (1900Boot) available
- Steel construction
- Standard frame finish is British White; blades are Black

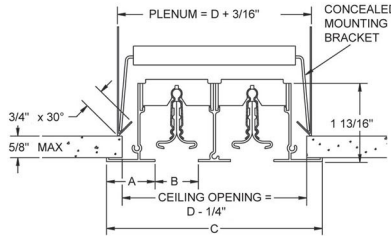

FRAME CROSS SECTION

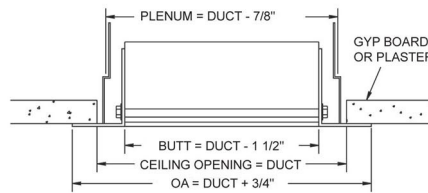

FRAME SIDE VIEW

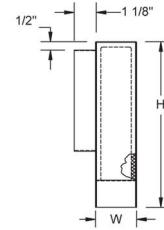

BOOT SIDE VIEW

PRODUCT INFORMATION & DIMENSIONS

SIZE	NUMBER OF 3/4" SLOTS	CFM @ NC-35	FRAME					INSULATED BOOT PLENUM			PRICE	PLENUM
			A	B	C	D	OA	INLET	W	H		
24"	2	150	1 1/8"	3/4"	4 1/2"	3 3/4"	23 3/4"	6"	3 15/16"	11"		
24"	4	300	1 1/8"	3/4"	7 1/2"	6 3/4"	23 3/4"	8"	6 15/16"	11"		
48"	2	325	1 1/8"	3/4"	4 1/2"	3 3/4"	47 3/4"	8"	3 15/16"	11"		
48"	4	650	1 1/8"	3/4"	7 1/2"	6 3/4"	47 3/4"	10"	6 15/16"	11"		

DUCT = ORDERED LENGTH, OA = OVERALL LENGTH

PTBSI - STEEL PLENUM SLOT DIFFUSER

- Combination slot diffuser with plenum for lay-in T-Bar ceiling systems
- Adjustable, gasketed aluminum straight blades
- Can be locked into place with blade screws
- Double metal thickness at slot face
- Steel construction
- Face and deflectors are standard Black
- Center-T is standard British White

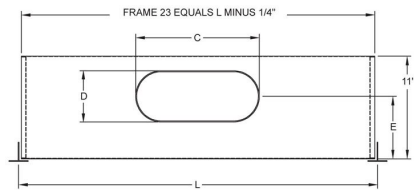

INLET SIDE VIEW

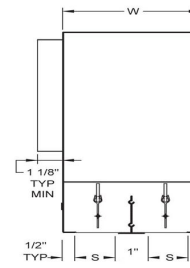

2 SLOT CROSS SECTION

PRODUCT INFORMATION & DIMENSIONS

SIZE	NUMBER OF 1" SLOTS	CFM @ NC-35	INLET SIDE VIEW					CROSS SECTION	PRICE	SURFACE MT FRAME
			SIZE	C	D	E	L	W		
24"	2	109	6"	6 1/4"	5 1/4"	6 3/8"	23 3/4"	4"		
48"	2	201	8"	9 3/8"	5 1/4"	6 3/8"	47 3/4"	4"		

RM1 - STEEL ROUND DIFFUSER WITH 3 CONES

- Horizontal only air distribution for heating and cooling
- 360° discharge air pattern
- For exposed duct or hard ceiling applications
- Two cone position adjustments
- Steel construction
- Standard finish is British White

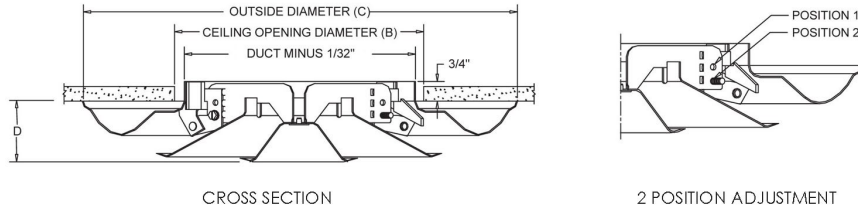

PRODUCT INFORMATION & DIMENSIONS								
NECK SIZE	CFM @ NC-25	CROSS SECTION				PRICE	DAMPER	
		B	C	D (1)	D (2)		PRN100	PR12
6"	200	6 1/2"	11 1/8"	1 3/4"	1 1/8"			
8"	315	8 1/2"	14 3/4"	2 1/8"	1 1/2"			
10"	475	10 1/2"	18 1/4"	2 1/8"	2 1/8"			
12"	630	12 1/2"	22"	3 1/8"	2 3/8"			
14"	850	14 1/2"	26"	3 3/8"	2 5/8"			
16"	1050	16 1/2"	29"	4"	3 1/4"			

5DMGDU - DOUBLE DEFLECTION SPIRAL DUCT MOUNTED GRILLE WITH DAMPER

- Double deflection
- Universal end caps
- Vertical front blades
- 3/4" blade spacing
- Aluminum construction
- Built-in backdraft damper
- Standard finish is Mill

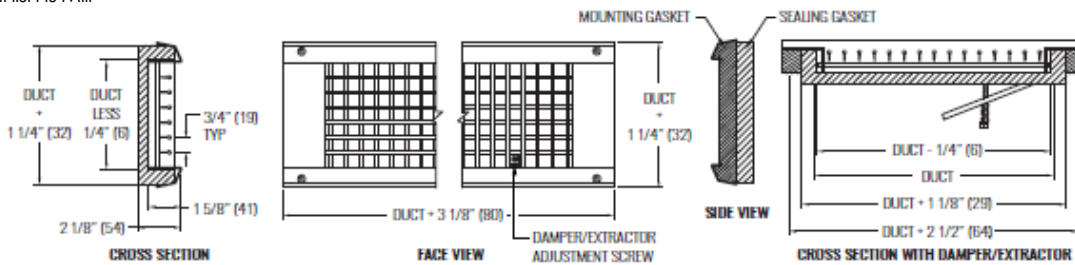

PRODUCT INFORMATION & DIMENSIONS			
SIZE	FITS PIPE SIZE	CFM@ NC-35	PRICE
12" x 3"	6" - 36"	175	
12" x 4"	10" - 36"	235	
12" x 6"	12" - 36"	355	
18" x 4"	10" - 36"	349	
18" x 6"	12" - 36"	525	

880H - DOUBLE DEFLECTION SUPPLY GRILLE

- Surface mount with screw holes
- Individually adjustable blades
- 3/4" blade spacing
- Horizontal front blades and vertical rear blades
- Steel construction
- Standard finish is British White

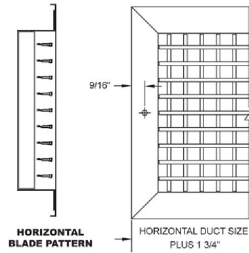

SIDE VIEW AND FACE VIEW

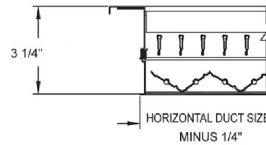

CROSS SECTION

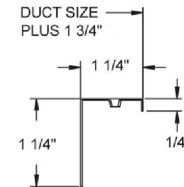

STANDARD FRAME

PRODUCT INFORMATION & DIMENSIONS

DUCT SIZE	CFM @ NC-35	PRICE	OBD	DUCT SIZE	CFM @ NC-35	PRICE	OBD
6" x 6"	200			20" x 6"	660		
8" x 6"	280			20" x 8"	900		
8" x 8"	360			20" x 10"	1050		
10" x 6"	330			20" x 16"	1700		
10" x 8"	450			24" x 6"	800		
10" x 10"	575			24" x 8"	1050		
12" x 4"	280			24" x 10"	1300		
12" x 6"	430			24" x 12"	1550		
12" x 8"	550			24" x 16"	1950		
12" x 10"	700			30" x 6"	700		
12" x 12"	800			30" x 8"	1300		
14" x 6"	450			30" x 10"	1600		
14" x 8"	640			30" x 12"	1900		
14" x 10"	800			30" x 18"	2700		
14" x 14"	825			36" x 8"	1500		
16" x 6"	550			36" x 12"	2200		
16" x 8"	720			36" x 18"	3200		
16" x 10"	900			36" x 24"	4269		
16" x 12"	980			48" x 6"	1550		
16" x 16"	1400			48" x 12"	3000		
18" x 6"	600			48" x 16"	3700		
18" x 8"	800						
18" x 10"	1000						
18" x 12"	1100						

S80H - SINGLE DEFLECTION RETURN GRILLE

- Surface mount with screw holes.
- 35° blade deflection
- 3/4" blade spacing
- Horizontal front blades and vertical rear blades
- Steel construction
- Standard finish is British White

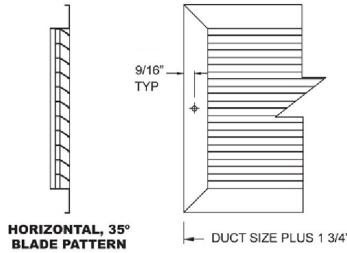

SIDE VIEW AND FACE VIEW

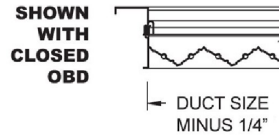

CROSS SECTION

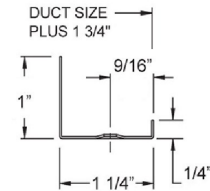

STANDARD FRAME

PRODUCT INFORMATION & DIMENSIONS

DUCT SIZE	CFM @ NC-35	PRICE	OBD	DUCT SIZE	CFM @ NC-35	PRICE	OBD
6" x 6"	190			20" x 20"	1640		
8" x 6"	260			24" x 6"	740		
8" x 8"	330			24" x 8"	900		
10" x 6"	370			24" x 10"	1140		
10" x 8"	400			24" x 12"	1300		
10" x 10"	550			24" x 16"	1570		
12" x 4"	290			24" x 18"	1800		
12" x 6"	410			24" x 20"	1650		
12" x 8"	520			24" x 24"	2100		
12" x 10"	630			30" x 12"	1460		
12" x 12"	750			30" x 18"	2100		
14" x 6"	480			30" x 24"	2700		
14" x 8"	600			30" x 30"	3400		
14" x 10"	740			36" x 12"	1700		
14" x 12"	800			36" x 18"	2400		
14" x 14"	930			36" x 24"	3250		
16" x 8"	640			36" x 30"	3900		
16" x 10"	780			36" x 36"	4500		
16" x 12"	930			48" x 12"	2200		
16" x 16"	1170			48" x 16"	3740		
18" x 10"	840			48" x 24"	4700		
18" x 12"	930			48" x 36"	5490		
18" x 18"	1350						
20" x 6"	630						
20" x 10"	900						
20" x 12"	1100						
20" x 16"	1370						
20" x 18"	1505						

LAY-IN APPLICATION				
DUCT SIZE	PANEL SIZE	CFM @ NC-35	PRICE	OBD
22" x 10"	24" x 12"	1025		
22" x 22"	24" x 24"	2000		
46" x 22"	48" x 24"	3600		

Grilles & Registers

S80H1FF, Sight-Guard, EG-5, ECPC, EGC-5, ECRD



S80H1FF - FILTER FRAME RETURN

- Horizontal fixed deflectors set at 35°
- ¾" spacing on center
- 1" filter frame standard
- Quarter turn fasteners for access to filter
- Steel construction
- Standard finish is British White



PRODUCT DIMENSIONS				
NECK SIZE	PANEL SIZE	APPLICATION	PRICE	1" FILTER PRICE
24" x 24"		SURFACE MT		
20" x 20"	24" x 24"	LAY-IN		

FILTER NOT INCLUDED: FILTER PURCHASED SEPERATELY

SIGHT-GUARD EGGCRATE RETURN GRILLE

- 45° angled eggcrate
- Lay-in application
- Aluminum construction
- Standard finish is British White



PRODUCT DIMENSIONS			
NECK SIZE	PANEL SIZE	CFM @ NC-35	PRICE
22" x 10"	24" x 12"	1200	
22" x 22"	24" x 24"	2400	

EG-5 - EGGCRATE CORE

- ½" x ½" x ½" eggcrate core
- Aluminum construction
- Standard finish is British White

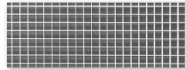

PRODUCT DIMENSIONS		
SIZE	CFM @ NC-35	PRICE
24" x 12"	1450	
24" x 24"	2550	

ECPC - PLASTIC EGGCRATE CORE

- ½" x ½" x ¾" eggcrate core
- Plastic construction
- Standard finish is White

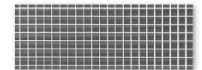

PRODUCT DIMENSIONS		
SIZE	CFM @ NC-35	PRICE
24" x 12"	1200	
24" x 24"	2400	
24" x 48"	4400	

EGC-5 - ALUMINUM EGGCRATE RETURN GRILLE

- ½" x ½" x ½" cube core
- 1¼" flange
- Surface mount or lay-in T-bar mount
- Aluminum frame
- Standard finish is British White

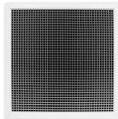

PRODUCT DIMENSIONS					
NECK SIZE	PANEL SIZE	CFM @ NC-35	APPLICATION	PRICE	OBD PRICE
6" x 6"		215	SURFACE MT		
8" x 8"		380	SURFACE MT		
10" x 10"		570	SURFACE MT		
12" x 12"		790	SURFACE MT		
14" x 14"		1000	SURFACE MT		
16" x 16"		1350	SURFACE MT		
18" x 18"		1660	SURFACE MT		
24" x 24"		2500	SURFACE MT		
22" x 10"	24" x 12"	1200	LAY-IN		
22" x 22"	24" x 24"	2400	LAY-IN		
22" x 46"	24" x 48"	4590	LAY-IN		

ECRD - EGGCRATE GRILLE WITH INTEGRAL PLENUM

- ½" x ½" x ½" aluminum core
- Lay-in application
- 2 ½" tall collar with raised bead
- 24 GA steel plenum: standard finish is Black
- Aluminum face: standard finish is British White



PRODUCT DIMENSIONS		
NECK SIZE	PANEL SIZE	PRICE
6"	24" x 12"	
8"	24" x 12"	
10"	24" x 12"	
10"	24" x 24"	
12"	24" x 24"	
14"	24" x 24"	
16"	24" x 24"	
18"	24" x 24"	

Grille & Register Accessories

Dampers, Square-to-Round Adaptor, Ceiling Frame, Thin Line Clip, Paint



PRN100 - STEEL RADIAL FAN DAMPER

- Radial fan damper
- Neck mounted
- Steel construction
- Standard finish is Mill



PRODUCT DIMENSIONS	
SIZE	PRICE
6"	
8"	
10"	
12"	
14"	

PR12 - STEEL BUTTERFLY BLADED DAMPER

- Butterfly bladed damper
- Duct mounted
- Steel construction
- Standard finish is Black



PRODUCT DIMENSIONS	
SIZE	PRICE
15"	
16"	
18"	
20"	

SRAC25 - STEEL SQUARE TO ROUND ADAPTOR

- Square to round for grilles or SH series diffusers
- Square part is 3/4" deep
- Steel construction
- Standard finish is Black

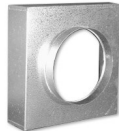

PRODUCT DIMENSIONS	
SIZE	PRICE
6" x 6" x 6"	
8" x 8" x 6"	
8" x 8" x 8"	
9" x 9" x 6"	
9" x 9" x 8"	
10" x 10" x 8"	
10" x 10" x 10"	
12" x 12" x 10"	
12" x 12" x 12"	
15" x 15" x 12"	
15" x 15" x 14"	
FIELD-CUT SQUARE TO ROUND	
22" x 10"	
22" x 22"	

OBDFA - STEEL OPERATED DAMPER

- Face operated oppose blade damper for SH series diffusers
- Neck mounted
- Steel construction
- Standard finish is Mill



PRODUCT DIMENSIONS	
SIZE	PRICE
6" x 6"	
9" x 9"	
12" x 12"	
15" x 15"	

OBD - STEEL DAMPER

- Opposed blade damper for grilles*
- Steel construction
- Standard finish is Mill



*SEE PAGES 22-23 FOR OBD SIZES

5HCF23 - HARD CEILING FRAME

- Hard ceiling frame
- Adapts F23 to F22
- Aluminum construction
- Standard finish is British White



PRODUCT DIMENSIONS	
SIZE	PRICE
12" x 12"	
24" x 12"	
24" x 24"	

ACCESSORIES

Thin Line Clip PRICE EACH...

Krueger Aerosol Can of Paint in British White PRICE EACH...

LMHS - SINGLE DUCT VAV

- Base unit or two row hot water coil unit available
- 22 GA galvanized steel casing construction
- ½" thick cellular liner
- AHRI and ETL Listed, meets NFPA 90A, UL 181 and ASTM C 665 requirements
- Hot water coils suitable for duct mounting applications (purchased separately)

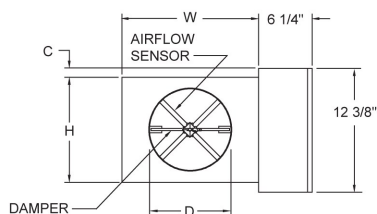

BASE UNIT INLET VIEW

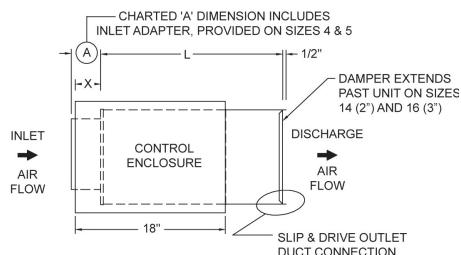

SIDE VIEW

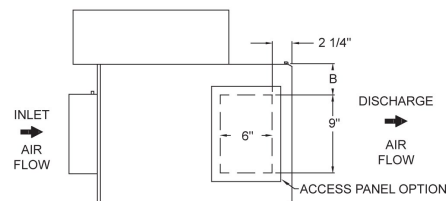

BOTTOM VIEW

SINGLE DUCT INFORMATION & DIMENSIONS										
UNIT SIZE	MAX CFM	DIMENSIONS								PRICE
		L	W	H	A	B	C	D	X	
5"	360	15 ½"	12"	8"	5 ⅞"	1 ½"	2 ⅙"	4 ⅞"	7 ¼"	
6"	515	15 ½"	12"	8"	3 ⅞"	1 ½"	2 ⅙"	5 ⅞"	7 ¼"	
8"	920	15 ½"	12"	10"	3 ⅞"	1 ½"	1 ⅙"	7 ⅞"	7 ¼"	
10"	1430	15 ½"	14"	12 ½"	3 ⅞"	2 ½"	N/A	9 ⅞"	5 ¼"	
12"	2060	15 ½"	16"	15"	3 ⅞"	3 ½"	N/A	11 ⅞"	5 ¼"	
14"	2800	15 ½"	20"	17 ½"	3 ⅞"	5 ½"	N/A	13 ⅞"	3 ¼"	
16"	3660	15 ½"	24"	18"	3 ⅞"	7 ½"	N/A	15 ⅞"	3 ¼"	

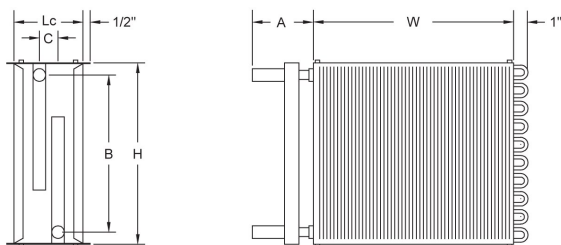

2 ROW HOT WATER COIL SIDE VIEW/FACE VIEW

2 ROW HOT WATER COIL INFORMATION & DIMENSIONS													
UNIT SIZE	CFM	DIMENSIONS						APD (INCHES W.G.)	WPD (INCHES W.G.)	GPM	MBH	LAT (F)	PRICE
		H	W	Lc	A	B	C						
5"	150	8"	12"	5"	4 ¼"	6 ⅞"	1 ⅙"	0.04	0.90	2	12.10	130	
6"	250	8"	12"	5"	4 ¼"	6 ⅞"	1 ⅙"	0.10	0.90	2	16.50	116	
8"	500	10"	12"	5"	4 ¼"	9 "	1 ⅙"	0.20	1.2	2	26.50	104	
10"	770	12 ½"	14"	5"	4 ¼"	11 ½"	1 ⅙"	0.22	0.70	2	36.20	98.50	
12"	1100	15 "	16"	5"	4 ¼"	13 ¾"	1 ⅙"	0.24	0.90	2	47.90	95	
14"	1600	17 ½"	20"	7 ½"	4 ¼"	16 ½"	1 ⅙"	0.23	0.60	2	61.70	90.75	
16"	1800	18"	24"	7 ½"	4 ¼"	16 ½"	1 ⅙"	0.21	0.30	2	64.80	88	

BASED ON 180°F EWT/55° EAT. COIL CONNECTION IS ⅞" O.D.

Dampers & Accessories

Dynamic Fire Rated, Dynamic Round, Ceiling Radiation, Accessories



AIR DISTRIBUTION

DYNAMIC RATED FIRE DAMPER

- Type A curtain style
- Vertical or horizontal mount
- 22 Ga frames
- 165° F fusible link
- 1½ hour UL 555 Fire Resistance Rated



PRODUCT DIMENSIONS	
SIZE	PRICE
6" x 6"	
8" x 6"	
8" x 8"	
10" x 6"	
10" x 8"	
10" x 10"	
12" x 6"	
12" x 8"	
12" x 10"	
12" x 12"	
14" x 6"	
14" x 8"	
14" x 10"	
14" x 12"	
14" x 14"	
16" x 6"	
16" x 8"	
16" x 10"	
16" x 12"	
16" x 14"	
16" x 16"	
18" x 6"	
18" x 8"	
18" x 10"	
18" x 12"	
18" x 14"	
18" x 18"	
20" x 6"	
20" x 8"	
20" x 10"	
20" x 12"	
20" x 14"	
20" x 16"	
20" x 18"	
20" x 20"	
22" x 10"	
24" x 6"	
24" x 8"	
24" x 10"	
24" x 12"	
24" x 14"	
24" x 16"	
24" x 18"	
24" x 20"	
24" x 24"	

DYNAMIC ROUND FIRE DAMPER

- Type C blades and frame out of air-stream
- Vertical or horizontal mount
- 4¼" 22 Ga 1 piece rollformed frame
- 165° F fusible link
- 1½ hour UL 555 Fire Resistance Rated

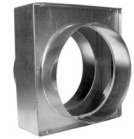

PRODUCT DIMENSIONS	
SIZE	PRICE
6"	
8"	
10"	
12"	
14"	

CEILING RADIATION DAMPER

- Horizontal mount
- 22 Ga frames
- 22 Ga butterfly blades
- 165° F fusible link
- 3 hour UL 555c Fire Resistance Rated



PRODUCT DIMENSIONS	
SIZE	PRICE
22" x 10"	
22" x 22"	

ROUND CEILING RADIATION DAMPER

- Horizontal mount
- 24 Ga frames
- 22 Ga round butterfly blades
- 165° F fusible link
- 3 hour UL 555c Fire Resistance Rated



PRODUCT DIMENSIONS	
SIZE	PRICE
6"	
8"	
10"	
12"	
14"	

ACCESSORIES

165° or 212° Fusible Links **PRICE EACH.....**

24" x 24" Radiation Blanket **PRICE EACH.....**

Dampers & Accessories

Control, Backdraft, Actuator, Manual Locking Quadrant



CONTROL DAMPER

- Automatic air control and manual balancing
- Medium pressure and velocity applications
- Triple-V opposed blades
- Rugged hat channel frame
- 1/2" drive rod
- 6" control shaft
- Linkage concealed in frame
- Synthetic bearings



PRODUCT DIMENSIONS	
SIZE	PRICE
12" x 12"	
16" x 12"	
16" x 16"	
16" x 24"	
18" x 12"	
18" x 18"	
20" x 16"	
20" x 20"	
24" x 12"	
24" x 16"	
24" x 20"	
24" x 24"	
24" x 36"	
30" x 16"	
30" x 30"	
36" x 12"	
36" x 16"	
36" x 24"	
36" x 36"	
48" x 24"	
48" x 36"	
48" x 48"	

BACKDRAFT DAMPER

- Restrict reverse airflow and permit forward flow of air in the intended direction
- Vertical or horizontal mount
- Exhaust installations
- Low to medium velocity and pressure applications
- Aluminum, gravity operated extruded style blades
- Aluminum frame
- Linkage exposed on blade
- Synthetic bearings



PRODUCT DIMENSIONS	
SIZE	PRICE
12" x 12"	
16" x 12"	
16" x 16"	
18" x 12"	
20" x 20"	
24" x 12"	
24" x 16"	
24" x 24"	
36" x 12"	
36" x 24"	
36" x 36"	
48" x 24"	

ACTUATORS

- 2-position spring return
- Fail safe operation



PRODUCT DIMENSIONS				
MODEL	VOLTS	ENCLOSURE	USE	PRICE
FSLF24	24V	1P30, NEMA 1	<12 sq. ft.	
FSLF120L	120V	IP30, NEMA 1, UL ENCL. TYPE I	<12 sq. ft.	
FSNF24	24V	IP40, NEMA 1	>12 sq. ft.	
FSNF120L	120V	IP40, NEMA 1	>12 sq. ft.	

MANUAL LOCKING QUADRANT

- 1/2" damper quadrant round shaft lock
- 18 GA zinc-plated steel (quadrant)
- 12 GA zinc-plated steel (handle)



PRODUCT INFORMATION	
ROD SHAFT SIZE	PRICE
1/2"	

STATIONARY LOUVER

- Prevents water penetration in non-wind-driven rain
- 37½° stationary drainable blades
- 4" deep channel frame
- ½" expanded and flattened aluminum screen
- Visible mullion
- 6063-T5 extruded aluminum standard Mill finish



PRODUCT DIMENSIONS			
SIZE	MAX CFM	FREE AREA	PRICE
12" x 12"	270	0.30"	
16" x 12"	373	0.40"	
16" x 16"	600	0.70"	
16" x 24"	1055	1.20"	
18" x 12"	450	0.50"	
18" x 18"	900	1.00"	
20" x 16"	782	0.90"	
20" x 20"	1077	1.20"	
24" x 12"	630	0.70"	
24" x 16"	964	1.10"	
24" x 24"	1800	2.00"	
24" x 36"	2880	3.20"	
30" x 16"	1237	1.40"	
30" x 30"	2970	3.30"	
36" x 12"	990	1.10"	
36" x 16"	1510	1.70"	
36" x 24"	2700	3.00"	
36" x 36"	4420	4.90"	
48" x 24"	3700	4.10"	
48" x 36"	6050	6.70"	
48" x 48"	8390	9.30"	

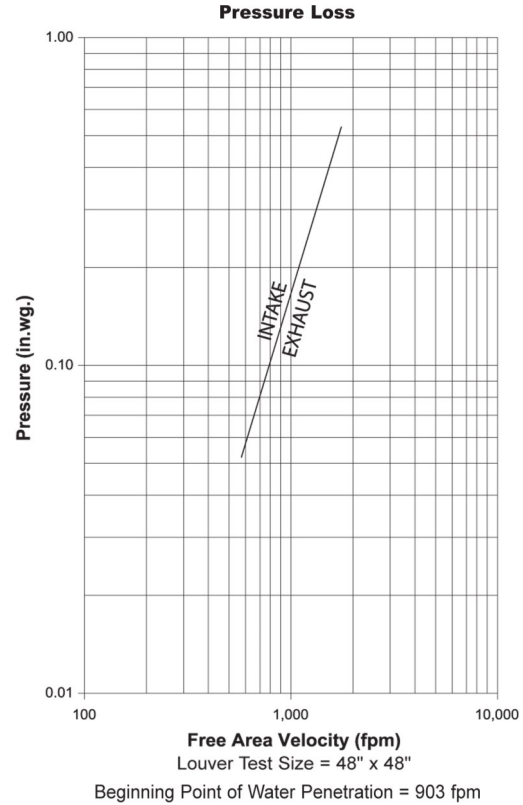

BRICK VENT— Aluminum EX 168

- New construction installation
- 45° blades
- All extruded sections
- Minimum 0.125" thickness
- 1" deep overlapping blade
- 204-R1 Clear Anodized finish



PRODUCT INFORMATION	
SIZE	PRICE
16 ½" x 7 ¾"	

BRICK VENT— Aluminum FL 168

- Renovations or existing wall installation
- 45° blades
- All extruded sections
- Minimum 0.125" thickness
- 1" deep overlapping blade
- 204-R1 Clear Anodized finish



PRODUCT INFORMATION	
SIZE	PRICE
16 ½" x 7 ¾"	

Radiant Tube Heating & Accessories

Radiant Tube Heater, Burner Box, Tube Set, Installation Kit



ERXL - RADIANT TUBE HEATER

- Gas-fired, low-intensity infrared heaters
- Includes a LP gas conversion kit
- Install as "Straight" or "U-tube" configuration
- Horizontal or 45° angle of reflectors
- Components sold separately
- 10-year Manufacturer Warranty*

Note: A Radiant Tube Heater System consists of the following: the ERXL Burner Box, the Heat Exchange Tube Set and the Radiant Heat Installation Kit. EACH SOLD SEPERATELY.



*Warranty limited to 2-years in ammonia, chlorine, chemical exposure and car wash installations. Contact salesperson for details.



STRAIGHT INSTALLATION



U-TUBE INSTALLATION

ERXL BURNER BOX

- 100% shut-off ignition device
- 120V, 60Hz, single phase
- Thermal overload motor protection, balanced air motor, combustion air proving safety pressure switch and viewing window for flame observation
- Pre-wired with a grounded electrical cord and plug
- LP conversion kit included



HEAT EXHANGER TUBE SET OR U-TUBE

- Round radiant heat tube with reflectors, hangers, stainless steel couplers with keys and vent adapter
- Various BTU/HR



STRAIGHT

- Optional 180° U-Tube connects two tubes together



U-TUBE

PRODUCT DIMENSIONS			
PRODUCT	BTU/HR INPUT	WIDTH x LENGTH	PRICE
ERXL-60N	60,000	9.25" x 17.75"	
ERXL-80N	80,000	9.25" x 17.75"	
ERXL-100N	100,000	9.25" x 17.75"	
ERXL-125N	125,000	9.25" x 17.75"	
ERXL-150N	150,000	9.25" x 17.75"	

PRODUCT DIMENSIONS				
PRODUCT	BTU/HR INPUT	DIA.	LENGTH	PRICE
ERXL-60/80	60,000	4"	20'	
ERXL-80	80,000	4"	30'	
ERXL-100/125	100,000	4"	30'	
ERXL-100/125	125,000	4"	40'	
ERXL-125/150	150,000	4"	50'	
180° U-Tube				

RADIANT HEAT INSTALLATION KIT

- 24V thermostat
- Vent cap
- 24" stainless steel flexible gas connector
- Gas shutoff valve and chain kits



PRODUCT DIMENSIONS			
PRODUCT	BTU/HR INPUT	TUBE LENGTH	PRICE
ERXL-60/80	60,000	20'	
ERXL-80	80,000	30'	
ERXL-100/125	100,000	30'	
ERXL-100/125	125,000	40'	
ERXL-125/150	150,000	50'	

SEASONAL PROMOTIONS



PORTABLE BUDDY RADIANT HEATER



PORTABLE GOLF CART RADIANT HEATER

Don't forget to ask about our Seasonal Promotions*. Please call your salesperson or our warehouse for details.

***Subject to availability. Deckman Company reserves the right to substitute promotional items at our discretion.**

V-MAX REPLACEMENT LAMPS

- Single non-encapsulated lamp
- Rated for 9,000 hrs. of lamp life
- Provides maximum UV-C irradiance
- Stocked in 21", 33", 48" and 61" lengths



Note: V-Max Replacement Lamps are used in both the V-Max Air Disinfection System and the V-Max Coil Cleaning System explained below.

V-MAX AIR DISINFECTION SYSTEM

Delivers Optimum UV Dose for Eliminating Airborne Pathogens

- Designed for AHU mounting on vertical supports
- Designed for duct-mounting parallel to the airstream providing optimum UV exposure
- Configurable to meet airstream kill rates up to 99% - backed by computational models to ensure performance
- Prewired lamp connection reduces installation time
- Low power consumption with universal voltage input
- Negligible pressure drop

V-MAX COIL CLEANING SYSTEM

Delivers Optimum UV Dose for Coil Cleaning and Maintenance

- Easy to install in both existing and new equipment
- Scalable design to fit any plenum size
- Fixtures can be mounted internally or externally
- Lamps can be easily mounted on vertical supports
- Minimal space required for installation
- Low power consumption with universal voltage input
- Negligible pressure drop

Contact Deckman Company for application specific information on V-Max Air Disinfection System and the V-Max Coil Cleaning System.

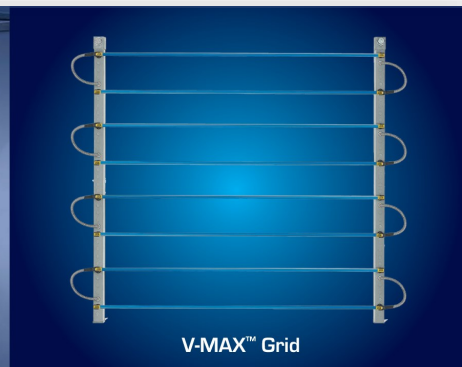
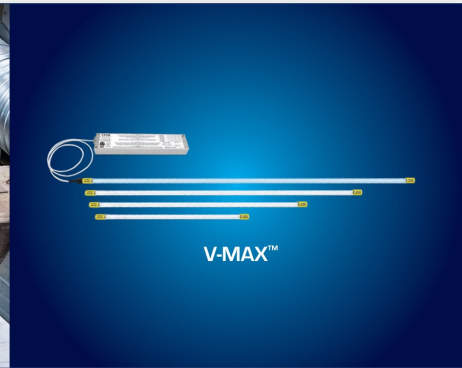

PCV50 & PCV80 and L-Series Fan

Ceiling Mount Ventilators



PCV50 / PCV80

- Premium CHOICE Series ceiling fan
- Quiet operation 1.5 to 2.5 sones
- 4" duct connector with built-in backdraft damper
- Steel housing, plastic grille and thermally protected motor
- cETLus Listed
- HVI Certified
- 5-year Manufacturer Warranty

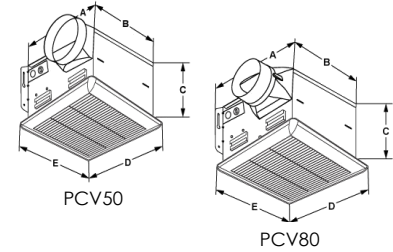

PRODUCT INFORMATION & DIMENSIONS

MODEL	DUCT	SONES @ 0.1" SP	CFM	Voltage (V)	WATTS @ 0.1" SP	CURRENT (AMPS)	DIMENSIONAL DATA					AVE. SHIP WEIGHT (LBS.)	PRICE
							A	B	C	D	E		
PCV50	4"	2.5	50	120	48.9	0.8	9	9	5.75	11.438	11.813	7	
PCV80*	4"	1.5	80	120	23.8	0.2	9	9	5.75	11.438	11.813	7	

*MODEL PCV80 IS ENERGY STAR® QUALIFIED

L-Series

- Ceiling mount ventilator with centrifugal blower wheel 120V/1PH
- Available with 6" or 8" round duct connector or 4½" x 18½" duct connector
- Galvanized steel housing with ½" acoustic insulation
- Automatic backdraft damper
- Mounting brackets
- 8-way adjustable mounting brackets
- AMCA licensed for air and sound performance
- UL Listed and cUL listed
- SC100W Variable Speed Control sold separately
- 1-year Manufacturer Warranty

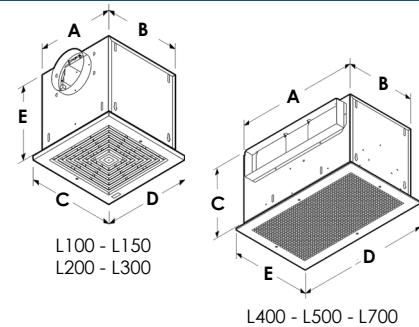

PRODUCT DIMENSIONS

MODEL	DIMENSIONS					OUTLET	AVE. SHIP WEIGHT	PRICE
	A	B	C	D	E			
L100/L150	12.25"	12.25"	14.00"	14.00"	11.75"	6.0"	23 lbs.	
L200/300	12.25"	12.25"	14.00"	14.00"	11.75"	8.0"	25 lbs.	
L400/L500/L700	12.25"	21.50"	14.00"	23.25"	11.75"	4.5" x 18.5"	35 lbs.	

PRODUCT INFORMATION & PERFORMANCE

MODEL	DUCT SIZE	RPM	WATTS	DISCHARGE PATTERN	STATIC PRESSURE (INCHES W.G.)									
					0	0.100	0.125	0.250	0.375	0.500	0.625	0.750	0.875	1.000
					CFM	CFM	CFM	CFM	CFM	CFM	CFM	CFM	CFM	CFM
L100	6"	640	87	HOR	136	115	109	93	80	65	44	12		
				VERT	138	117	112	94	80	67	46	13		
L150	6"	710	100	HOR	181	161	157	141	132	124	114	94	62	
				VERT	179	163	160	149	142	133	122	105	73	23
L200	8"	740	127	HOR	231	214	210	196	186	177	165	144	113	51
				VERT	224	210	207	197	187	179	167	144	99	41
L300	8"	905	212	HOR	312	309	308	303	296	287	273	254	219	125
				VERT	319	314	313	306	299	288	274	251	219	120
L400	4½" x 18½"	735	146	HOR	480	442	434	388	344	299	299	182	114	33
				VERT	467	428	416	378	335	291	237	170	85	8
L500	4½" x 18½"	810	232	HOR	538	520	514	491	463	434	389	339	282	186
				VERT	539	517	512	481	451	418	367	319	247	137
L700	4½" x 18½"	960	313	HOR	722	704	701	667	640	607	571	534	453	333
				VERT	708	691	687	658	628	597	560	515	444	312

Fan Accessories

Speed Controller, In-Line Adaptor, LED Lighting, Brick Vents, Roof Caps, Wall Caps

VARIABLE SPEED CONTROLLER

MODEL SC100W

- Adjusts blower speed and sound level
- Switch fits in a single gang box
- 120V at 60Hz, max of 3 amps/switch
- Faceplate not included



INLINE ADAPTOR FOR L-SERIES

MODEL 961L/981L/982L

- 24 GA steel
- Mounting hardware included
- FAN 961L: L100 / L150
- FAN 981L: L200 - L300
- FAN 982L: L400 - L700



961L/981L



982L

LED LIGHTING FOR PCV50 OR PCV80

MODEL PCVLEDK

- LED light kit
- 13 watt LED light
- 4100K/1100 lumens
- Simple plug-in receptacle in fan housing
- Install with new fan or as an add-on later



BRICK VENTS

MODEL EX168/FL168

- EX = New construction
- FX = Existing or renovation
- 16 1/2" x 7 3/4" w/ 45° blades
- Clear Anodized finish



EX-168



FX-168

ROOF CAPS

MODEL 611

- Flat roof installation
- Built-in birdscreen
- Aluminum natural finish
- DUCT: up to 8" round
- FANS: L100 - L300



611

MODEL 612

- Flat roof installation
- Built-in birdscreen
- Aluminum natural finish
- DUCT: up to 12" round
- FANS: L300 - L700



612

MODEL 437

- Built-in birdscreen
- Steel housing with black finish
- DUCT: up to 12" round
- FANS: L400 - L700



437

MODEL 634P

- Built-in backdraft damper
- Built-in birdscreen
- Steel housing with black finish
- DUCT: 3 1/4" x 10" or up to 8" round
- FANS: L100 - L300



634P

MODEL 636

- Built-in backdraft damper
- Built-in birdscreen
- Steel housing with black finish
- DUCT: 3" or 4" round
- FANS: PCV50 / PCV80



636

WALL CAPS

MODEL 613

- Built-in backdraft damper
- Built-in birdscreen
- Aluminum natural finish
- DUCT: 12" round
- FANS: L400 - L700



613

MODEL 641

- Built-in backdraft damper
- Built-in birdscreen
- Aluminum natural finish
- DUCT: 6" round
- FANS: L100/L150



641

MODEL 642

- Aluminum natural finish
- DUCT: 3" - 4" round
- FANS: PCV50 / PCV80



642

MODEL 643

- Aluminum natural finish
- DUCT: 8" round
- FANS: L200 - L700



643

Model DX

Centrifugal Roof Exhauster



DOMEX (DX)

- Direct drive, downblast, roof mount
- 115V/1PH/60Hz
- Spun aluminum downblast fan
- Standard galvanized steel curb cap
- Self-Aligning bearings
- Vibration isolators
- Reverse venturi
- Aluminum wheels
- Open drip proof motor
- Bird screen
- Disconnect plug
- Includes solid state speed controller (loose)
- Includes backdraft damper (loose)

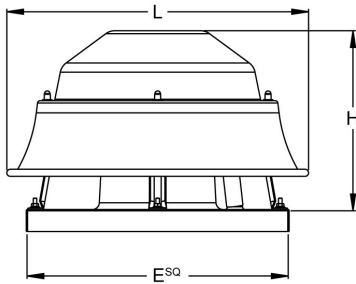

Model DX10

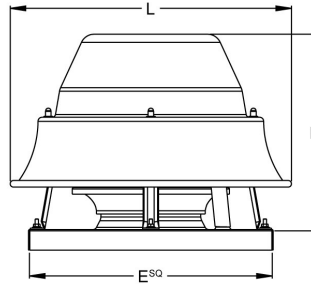

Model DX13

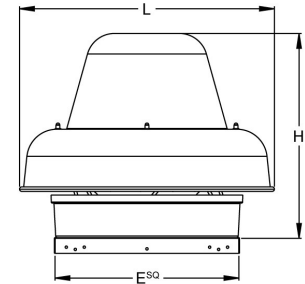

Model DX16 / DX18

PRODUCT DIMENSIONS

MODEL	DIMENSIONS				AVERAGE SHIP WEIGHT	BACKDRAFT DAMPER	12" HIGH ROOF CURB
	L Dia.	H	E sq.	RO sq.			
DX10	20 7/8"	13 3/8"	18 1/2"	11 1/2"	29 lbs.	11.25" x 11.25"	17" x 17" x 12"
DX13	21 7/16"	14 3/4"	18 1/2"	11 1/2"	38 lbs.	11.25" x 11.25"	17" x 17" x 12"
DX16	28 1/2"	22 1/2"	20 1/2"	16"	56 lbs.	15.75" x 15.75"	19" x 19" x 12"
DX18	39"	31"	28 1/2"	20"	78 lbs.	19.75" x 19.75"	27" x 27" x 12"

OUTSIDE DIMENSIONS OF CURB SHOULD BE 1 1/2" LESS THAN "E" DIMENSION

PRODUCT INFORMATION & DIMENSIONS

MOTOR		RPM	STATIC PRESSURE (INCHES W.G.)									MOTOR SPEED	FAN PRICE	ROOF CURB PRICE
SIZE	HP		0	0.125	0.250	0.375	0.500	0.625	0.750	0.875	1.000			
			CFM	CFM	CFM	CFM	CFM	CFM	CFM	CFM	CFM			
10	1/25	1300	385	316	257	207	168	129	82			Multi		
13	1/6	1550	1054	988	917	839	736	651	579	510	428	Multi		
16	1/3	1300	2021	1822	1637	1428	1256	1094	943	850	775	Multi		
18	3/4	1075	4561	4395	4230	4053	3865	3671	3454	3237	2995	Multi		

FAN INCLUDES SOLID STATE SPEED CONTROLLER (LOOSE) AND BACKDRAFT DAMPER (LOOSE)

Fan and Roof Accessories

Roof Curb, Equipment Rail, Pipe Portal System, Deckmate, Alumi-Flash

ROOF CURB / DOUBLE CURB

- 18 GA G90 galvanized
- Self-Flashing
- Fully welded construction
- 1½" 3 lb. density insulation (R6)
- Untreated wood nailer

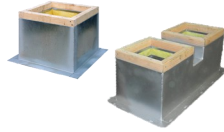

PRODUCT DIMENSIONS		
SIZE (LxW)	HEIGHT	PRICE
12" x 12"	12"	
17" x 17"	12"	
19" x 19"	12"	
27" x 27"	12"	
DOUBLE CURB		
27 ½" x 12"	12"	

EQUIPMENT RAIL

- 18 GA G90 galvanized
- Self-flashing
- Fully welded construction
- Untreated wood nailer with metal cover
- 2" flange out



PRODUCT DIMENSIONS			
MODEL	LENGTH	HEIGHT	PRICE
ER-2A	2'	12"	
ER-2A	3'	12"	
ER-2A	4'	12"	
ER-2A	5'	12"	
ER-2A	8'	12"	

COMPLETE PIPE PORTAL SYSTEM

- SINGLE SYSTEM: Curb, single cover and cap
- DOUBLE SYSTEM: Double curb, two (2) single covers and two (2) caps



PRODUCT INFORMATION		
MODEL	SINGLE SYSTEM PRICE	DOUBLE SYSTEM PRICE
N18 Complete		
N21 Complete		
N28 Complete		
N62 Complete		

CAP & COVER

- EPDM rubber cap with stainless steel cap clamps
- ABS plastic curb cover



INDIVIDUAL PRODUCT INFORMATION			
MODEL	OPENINGS	SIZE(S)	PRICE
N18 Cap w/Clamps	4	¾" to 1"	
N21 Cap w/Clamps	4	1" to 2"	
N28 Cap w/Clamps	4	AND (2) ¾" to 1" (2) 1" to 2"	
N62 Cap w/Clamps	1	2" to 6"	
Single Cover	1		

DECK MATE

- Positive seal for corrugated decks
- Stainless steel clamp included

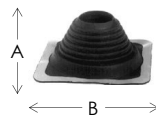

PRODUCT DIMENSIONS				
MODEL	PIPE SIZE	DIMENSIONS		PRICE
		A (HT)	B (L)	
DM 3	¼" to 4"	4"	8"	
DM 4	3" to 6"	5"	10"	
DM 5	4" to 7"	5"	11"	
DM 6	5" to 9"	6"	12"	
DM 7	6" to 11"	6"	14"	
DM 8	7" to 13"	6"	17"	
DM 9	10" to 18"	8"	25"	

ALUMI-FLASH

- Pipe portal base for hot applied roof systems (makes pitch pans obsolete)



PRODUCT DIMENSIONS			
HEIGHT	DIAMETER	OPENING	PRICE
4"	14"	8"	

Manufacturer Offerings

Stock and Factory Direct

- ABSOLUTAIRE** Direct-Fired Heating and Ventilating Equipment
- ACOUSTIFLO** Custom Designed Centrifugal Fans
- ACT** Heat Pipes for Thermal Management • HVAC Heat Exchangers
- ATI (AIRE TECHNOLOGIES)** Fire Dampers • Ceiling Radiation Dampers
- ALDES** Commercial & Residential Heat and Energy Recovery • Airflow & Zone Controls
Make-Up Air & Fan Selection
- AMPCO** B-Vent • Grease Duct • Positive and Negative Pressure Pipe
- BERKO** Electric Heating Products
- BROAN** Bath and Ventilation Fans • Range Hoods
- CAR-MON** Auto, Truck and Welding Fume Exhaust Systems
- COONEY** Replacement HVAC Coils • Tube Bundles • Heat Exchangers
- CORE** Energy Recovery Units
- DUCTMATE** Duct Connectors • Insulation • Access Doors • Duct Sealants • Adhesives
Reinforcements and Hangers • T.D.C. and T.D.F Components • Vane Systems
- ENVIRO-TEC** Air Terminal Boxes • Air Handling Units • Fan Coil Units
- FABRICAIR** Fabric Air Duct
- FILTRATION GROUP** Pleated, Cartridge and Carbon HEPA Filters • BIBO and Side Access Filter Housings
- FLÄKTWOODS** Axial Flow Ventilation Fans
- GSI** Greenseam Pipe & Fittings • Sheet Metal Specialties
- FLEXMASTER** Flexible Air Duct • Sheet Metal Specialties
- HAAKON** Custom Air Handling Units
- HEATSTAR** ERXL Radiant Tube Heaters • High Intensity Infrared Heaters
- HUNTER** HVLS Ceiling Fans
- INNOVENT** Custom AHUs with Energy Recovery • Refrigeration Components • Pool Dehumidification
- INTEC CONTROLS** Gas Detection Systems
- KINETICS** Sound Attenuators • Equipment Enclosures
- KRUEGER** Grilles • Registers • Diffusers • Air Terminal Boxes • Underfloor Air Distribution
- LG** Ducted and Non-Ducted Mini-Split Systems • Multi-Zone Split System Fans • PTACs
- LIFEBREATH** Indoor Air Quality and Ventilation Products
- LTG** Air-Water Systems
- MK PLASTICS** Laboratory Exhaust Fans • FRP Fans
- PENNBARRY** Fans • Gravity Vents • Industrial Blowers • Penthouses • Corrosion-Resistant Fans • Ventilators
- POOLPAK** Swimming Pool Heat Recovery and Humidity Control Units
- POTTORFF** Air Control and Backdraft Dampers • Ceiling Radiation Dampers • UL Rated Fire Dampers
Fire -Smoke and Smoke Dampers • Louvers and Penthouses • Actuators
- PRECISION COILS** Water, Steam and DX Coils
- QUANTECH** Air-Cooled Chillers
- RPS** Roof Curbs • Equipment Rails • Pipe Portals • Pedestals
- SEMCO** Spiral Duct • Equipment Enclosures • Sound Attenuators
- SMARDT** Oil Free High Efficiency Chillers
- S&P (SOLER PALAU)** Garage Ventilation • Multi-Family Ventilation
- STEAMOVAP** Electric and Steam Humidification Systems
- STELPRO** Electric Heating Units
- UVDI** Modular Ultra-Violet Lamp Systems
- VALENT** Packaged Roof Top Units with Energy Recovery
- VMC GROUP** Vibration Isolation Systems



Company Information

Terms and Conditions, Directions

TERMS AND CONDITIONS

Prices: All prices are subject to change without notice. Merchandise will be billed at the prices in effect at time of shipment and are F.O.B. original shipping point. Prices do not include applicable Federal, State, and/or local taxes. Prices are based on an individual product basis, unless otherwise noted. Deckman Company will make a written quotation on specific merchandise. Such quotations are binding only for thirty (30) days after issue, unless special consideration is stated.

Terms: Payment of the full purchase price for equipment and merchandise here offered, plus taxes and freight where applicable, unless otherwise stated by Deckman Company, shall be due net thirty (30) days from date of invoice with a service charge of 2% of the invoiced amount applying to the unpaid balance for each month, or fraction thereof, for invoices not paid in full after thirty (30) days. If, in the sole discretion of Deckman Company, the Buyer's credit is impaired at any time, Deckman Company shall have the right, without incurring any liability, to change the terms of payment, stop shipment, or cancel the order.

Claims and Adjustments: Equipment and/or merchandise claimed to be defective as to workmanship or material is subject to manufacturer's inspection. Deckman Company will adjust such claims with the manufacturer but shall not assume obligation for the claims, or for consequential damages, or for any labor or other expenses incurred by reason of the use or sale of any defective equipment or material. The responsibility of Deckman Company ceases upon delivery of equipment and merchandise in good order to the carrier. All goods are shipped at Buyer's risk. Deckman Company will assist the Buyer in any reasonable way possible in the filing and collection of any claim for damages or loss in transit.

Warranties: Descriptions of equipment and merchandise contained in this catalog are for the sole purpose of identification of the same. No such description can be made part of the basis of a bargain nor create an express or implied warranty that the goods conform to or are fit for any particular purpose. Although Deckman Company makes no warranties, expressed or implied, including that or merchantability and fitness of purpose, it does extend to the Buyer the manufacturer's warranty. (Copies of which are available upon request.) In extending this warranty, Deckman Company will not be liable for any damages by reason of failure of the equipment or merchandise to operate, nor shall it be held responsible for any direct, incidental, or consequential damages or losses, including but not limited to, cost of use, income, profit or production or spoilage or increased loss of operation resulting from installation, operation or use of the equipment or merchandise.

General: (1) Deckman Company is entitled to rely upon the receipt of a written purchase order of the Buyer in sufficient detail to enable it to fulfill said order. (2) The Buyer is liable, should an order be cancelled through no fault of Deckman Company, for any and all expenses incurred by Deckman Company in connection with the order. (3) All repairs are made on an F.O.B. original shipping point basis and transportation charges on materials returned for repair must be prepaid. (4) Merchandise may not be returned except by permission of Deckman Company. In addition to any other rights and remedies available to Deckman Company, all merchandise shall be returned within thirty (30) days, in new condition and in original containers. A restocking and/or handling fee equal to 25% of the invoice price of such merchandise will be applied. Returned merchandise must include a Returned Goods Authorization Form. Only items that originated from Deckman Company's inventory may be considered for return. (5) The obligation of Deckman Company to fulfill request of the Buyer in accordance with these terms of sale is conditioned upon Buyer paying in full the purchase price for all merchandise related to the request. (6) Deckman Company shall not be liable for failure or delay in making delivery when such failure or delay is beyond its reasonable control. (7) If Deckman Company initiates action to enforce payment for merchandise, Buyer agrees to pay reasonable attorney's fees and costs as may be incurred. (8) All cartons/merchandise must be inspected and any damage claim must be reported within 48 hours of delivery.

Applicability: A copy of this document shall be attached, incorporated by reference, or deemed to be attached to Buyer's purchase order when accepted by Deckman Company.

DIRECTIONS TO THE PITTSBURGH OFFICE AND WAREHOUSE

Deckman Company
1200 Cuddy Lane
Cuddy, PA 15031
(412) 257-3333

- Travel Interstate 79 to Bridgeville Exit #54
- Turn left at traffic light onto PA-50 West
- Travel 0.4 miles
- Turn right onto Miller's Run Road
- Travel Miller's Run Road for 1.5 miles
- Turn right onto Morgan Hill Road
- Turn left after the bridge onto Cuddy Lane
- Deckman Company is located on the right

Warehouse/Office Hours:
Monday - Friday
7:30 am - 4:00 pm

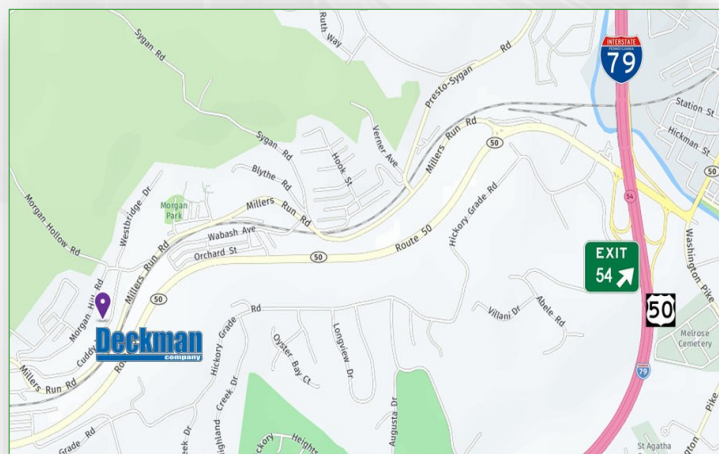



Deckman

company

COMMERCIAL HVAC WAREHOUSE

1200 Cuddy Lane • Cuddy, PA 15031
412-257-3333 • www.deckmanco.com